

Chapter 9

POWER AND REFRIGERATION CYCLES

Two important areas of application for thermodynamics are power generation and refrigeration. Both power generation and refrigeration are usually accomplished by systems that operate on a thermodynamic cycle. Thermodynamic cycles can be divided into two general categories: *power cycles* and *refrigeration cycles*.

The devices or systems used to produce a net power output are often called *engines*, and the thermodynamic cycles they operate on are called *power cycles*. The devices or systems used to produce refrigeration are called *refrigerators*, *air conditioners*, or *heat pumps*, and the cycles they operate on are called *refrigeration cycles*.

Thermodynamic cycles can also be categorized as *gas cycles* or *vapor cycles*, depending on the *phase* of the working fluid—the substance that circulates through the cyclic device. In gas cycles, the working fluid remains in the gaseous phase throughout the entire cycle, whereas in vapor cycles the working fluid exists in the vapor phase during one part of the cycle and in the liquid phase during another part.

Thermodynamic cycles can be categorized yet another way: *closed* and *open cycles*. In closed cycles, the working fluid is returned to the initial state at the end of the cycle and is recirculated. In open cycles, the working fluid is renewed at the end of each cycle instead of being recirculated. In automobile engines, for example, the combustion gases are exhausted and replaced by fresh air–fuel mixture at the end of each cycle. The engine operates on a mechanical cycle, but the working fluid in this type of device does not go through a complete thermodynamic cycle.

Heat engines are categorized as *internal combustion* or *external combustion engines*, depending on how the heat is supplied to the working fluid. In external combustion engines (such as steam power plants), energy is supplied to the working fluid from an external source such as a furnace, a geothermal well, a nuclear reactor, or even the sun. In internal combustion engines (such as automobile engines), this is done by burning the fuel within the system boundary. In this chapter, various gas power cycles are analyzed under some simplifying assumptions.

Steam is the most common working fluid used in vapor power cycles because of its many desirable characteristics, such as low cost, availability, and high enthalpy of vaporization. Other working fluids used include sodium, potassium, and mercury for high-temperature applications and some organic fluids such as benzene and the freons for low-temperature applications.

Steam power plants are commonly referred to as *coal plants*, *nuclear plants*, or *natural gas plants*, depending on the type of fuel used to supply heat to the steam. But the steam goes through the same basic cycle in all of them. Therefore, all can be analyzed in the same manner.

The most frequently used refrigeration cycle is the *vapor-compression refrigeration cycle* in which the refrigerant is vaporized and condensed alternately and is compressed in the vapor phase.

Objectives

The objectives of this chapter are to:

- Evaluate the performance of gas power cycles.
- Develop simplifying assumptions applicable to gas power cycles.
- Review the operation of reciprocating engines.
- Solve problems based on the Otto and Diesel cycles.
- Solve problems based on the Brayton cycle and the Brayton cycle with regeneration.
- Analyze vapor power cycles in which the working fluid is alternately vaporized and condensed.
- Investigate ways to modify the basic Rankine vapor power cycle to increase the cycle thermal efficiency.
- Analyze the reheat vapor power cycles.
- Analyze the ideal vapor-compression refrigeration cycle.
- Analyze the actual vapor-compression refrigeration cycle.
- Discuss the operation of refrigeration and heat pump systems.

2 | Fundamentals of Thermal-Fluid Sciences

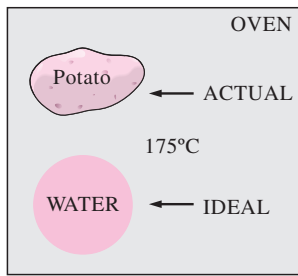

FIGURE 1

Modeling is a powerful engineering tool that provides great insight and simplicity at the expense of some loss in accuracy.

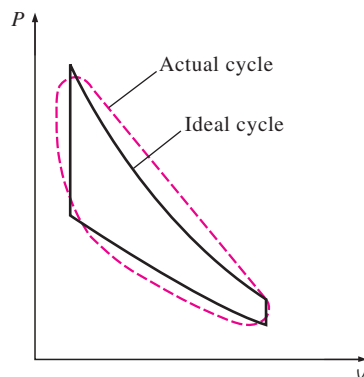

FIGURE 2

The analysis of many complex processes can be reduced to a manageable level by utilizing some idealizations.



FIGURE 3

Care should be exercised in the interpretation of the results from ideal cycles.

© Reprinted with special permission of King Features Syndicate.

1 ■ BASIC CONSIDERATIONS IN THE ANALYSIS OF POWER CYCLES

Most power-producing devices operate on cycles, and the study of power cycles is an exciting and important part of thermodynamics. The cycles encountered in actual devices are difficult to analyze because of the presence of complicating effects, such as friction, and the absence of sufficient time for establishment of the equilibrium conditions during the cycle. To make an analytical study of a cycle feasible, we have to keep the complexities at a manageable level and utilize some idealizations (Fig. 1). When the actual cycle is stripped of all the internal irreversibilities and complexities, we end up with a cycle that resembles the actual cycle closely but is made up totally of internally reversible processes. Such a cycle is called an **ideal cycle** (Fig. 2).

A simple idealized model enables engineers to study the effects of the major parameters that dominate the cycle without getting bogged down in the details. The cycles discussed in this chapter are somewhat idealized, but they still retain the general characteristics of the actual cycles they represent. The conclusions reached from the analysis of ideal cycles are also applicable to actual cycles. The thermal efficiency of the Otto cycle, the ideal cycle for spark-ignition automobile engines, for example, increases with the compression ratio. This is also the case for actual automobile engines. The numerical values obtained from the analysis of an ideal cycle, however, are not necessarily representative of the actual cycles, and care should be exercised in their interpretation (Fig. 3). The simplified analysis presented in this chapter for various power cycles of practical interest may also serve as the starting point for a more in-depth study.

Heat engines are designed for the purpose of converting thermal energy to work, and their performance is expressed in terms of the **thermal efficiency** η_{th} , which is the ratio of the net work produced by the engine to the total heat input:

$$\eta_{th} = \frac{W_{net}}{Q_{in}} \quad \text{or} \quad \eta_{th} = \frac{w_{net}}{q_{in}} \quad (1)$$

Recall that heat engines that operate on a totally reversible cycle, such as the Carnot cycle, have the highest thermal efficiency of all heat engines operating between the same temperature levels. That is, nobody can develop a cycle more efficient than the *Carnot cycle*. Then the following question arises naturally: If the Carnot cycle is the best possible cycle, why do we not use it as the model cycle for all the heat engines instead of bothering with several so-called *ideal cycles*? The answer to this question is hardware-related. Most cycles encountered in practice differ significantly from the Carnot cycle, which makes it unsuitable as a realistic model. Each ideal cycle discussed in this chapter is related to a specific work-producing device and is an *idealized* version of the actual cycle.

The ideal cycles are *internally reversible*, but, unlike the Carnot cycle, they are not necessarily externally reversible. That is, they may involve irreversibilities external to the system such as heat transfer through a finite temperature difference. Therefore, the thermal efficiency of an ideal cycle, in general, is less than that of a totally reversible cycle operating between the

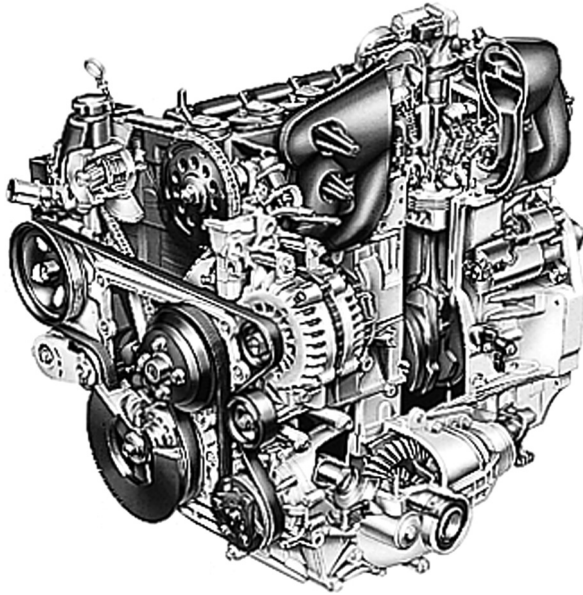
**FIGURE 4**

An automotive engine with the combustion chamber exposed.

Courtesy of General Motors

same temperature limits. However, it is still considerably higher than the thermal efficiency of an actual cycle because of the idealizations utilized (Fig. 4).

The idealizations and simplifications commonly employed in the analysis of power cycles can be summarized as follows:

1. The cycle does not involve any *friction*. Therefore, the working fluid does not experience any pressure drop as it flows in pipes or devices such as heat exchangers.
2. All expansion and compression processes take place in a *quasi-equilibrium* manner.
3. The pipes connecting the various components of a system are well insulated, and *heat transfer* through them is negligible.

Neglecting the changes in *kinetic* and *potential energies* of the working fluid is another commonly utilized simplification in the analysis of power cycles. This is a reasonable assumption since in devices that involve shaft work, such as turbines, compressors, and pumps, the kinetic and potential energy terms are usually very small relative to the other terms in the energy equation. Fluid velocities encountered in devices such as condensers, boilers, and mixing chambers are typically low, and the fluid streams experience little change in their velocities, again making kinetic energy changes negligible. The only devices where the changes in kinetic energy are significant are the nozzles and diffusers, which are specifically designed to create large changes in velocity.

In the preceding chapters, *property diagrams* such as the P - v and T - s diagrams have served as valuable aids in the analysis of thermodynamic processes. On both the P - v and T - s diagrams, the area enclosed by the process curves of a cycle represents the net work produced during the cycle (Fig. 5), which is also equivalent to the net heat transfer for that cycle. The

4 | Fundamentals of Thermal-Fluid Sciences

FIGURE 5

On both P - v and T - s diagrams, the area enclosed by the process curve represents the net work of the cycle.

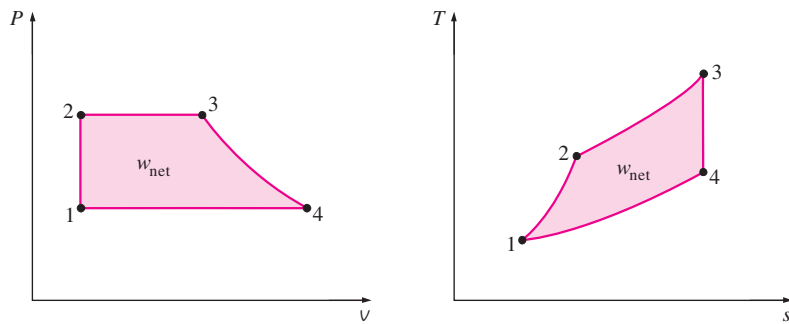

T - s diagram is particularly useful as a visual aid in the analysis of ideal power cycles. An ideal power cycle does not involve any internal irreversibilities, and so the only effect that can change the entropy of the working fluid during a process is heat transfer.

On a T - s diagram, a *heat-addition* process proceeds in the direction of increasing entropy, a *heat-rejection* process proceeds in the direction of decreasing entropy, and an *isentropic* (internally reversible, adiabatic) process proceeds at constant entropy. The area under the process curve on a T - s diagram represents the heat transfer for that process. The area under the heat addition process on a T - s diagram is a geometric measure of the total heat supplied during the cycle q_{in} , and the area under the heat rejection process is a measure of the total heat rejected q_{out} . The difference between these two (the area enclosed by the cyclic curve) is the net heat transfer, which is also the net work produced during the cycle. Therefore, on a T - s diagram, the ratio of the area enclosed by the cyclic curve to the area under the heat-addition process curve represents the thermal efficiency of the cycle. *Any modification that increases the ratio of these two areas will also increase the thermal efficiency of the cycle.*

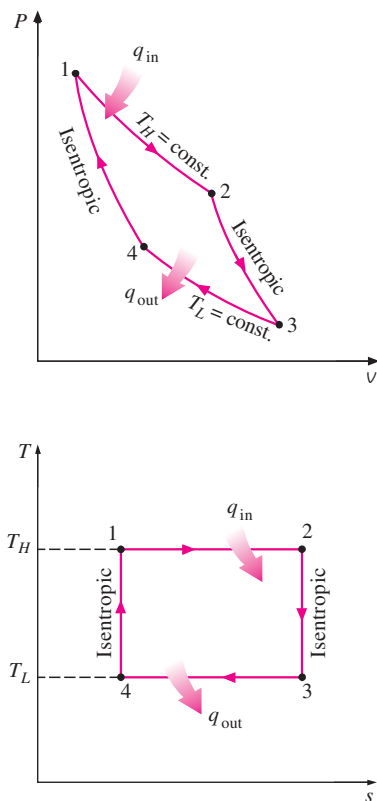

FIGURE 6

P - v and T - s diagrams of a Carnot cycle.

Although the working fluid in an ideal power cycle operates on a closed loop, the type of individual processes that comprises the cycle depends on the individual devices used to execute the cycle. In the Rankine cycle, which is the ideal cycle for steam power plants, the working fluid flows through a series of steady-flow devices such as the turbine and condenser, whereas in the Otto cycle, which is the ideal cycle for the spark-ignition automobile engine, the working fluid is alternately expanded and compressed in a piston-cylinder device. Therefore, equations pertaining to steady-flow systems should be used in the analysis of the Rankine cycle, and equations pertaining to closed systems should be used in the analysis of the Otto cycle.

2 ■ THE CARNOT CYCLE AND ITS VALUE IN ENGINEERING

The Carnot cycle is composed of four totally reversible processes: isothermal heat addition, isentropic expansion, isothermal heat rejection, and isentropic compression. The P - v and T - s diagrams of a Carnot cycle are replotted in Fig. 6. The Carnot cycle can be executed in a closed system (a piston-cylinder device) or a steady-flow system (utilizing two turbines and two compressors, as shown in Fig. 7), and either a gas or a vapor can be

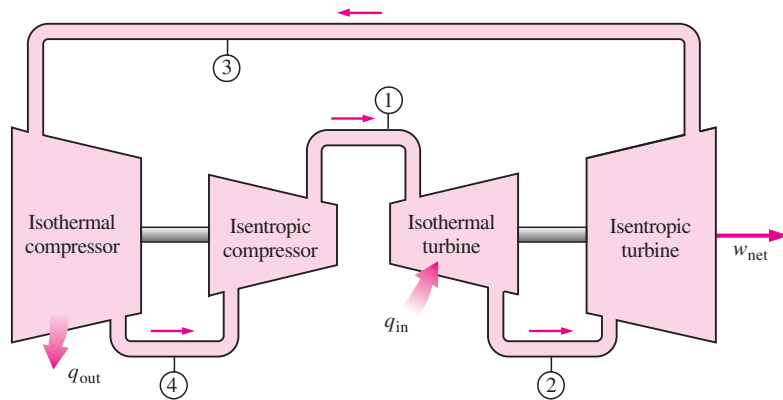

FIGURE 7

A steady-flow Carnot engine.

utilized as the working fluid. The Carnot cycle is the most efficient cycle that can be executed between a heat source at temperature T_H and a sink at temperature T_L , and its thermal efficiency is expressed as

$$\eta_{\text{th,Carnot}} = 1 - \frac{T_L}{T_H} \quad (2)$$

Reversible isothermal heat transfer is very difficult to achieve in reality because it would require very large heat exchangers and it would take a very long time (a power cycle in a typical engine is completed in a fraction of a second). Therefore, it is not practical to build an engine that would operate on a cycle that closely approximates the Carnot cycle.

The real value of the Carnot cycle comes from its being a standard against which the actual or the ideal cycles can be compared. The thermal efficiency of the Carnot cycle is a function of the sink and source temperatures only, and the thermal efficiency relation for the Carnot cycle (Eq. 2) conveys an important message that is equally applicable to both ideal and actual cycles: *Thermal efficiency increases with an increase in the average temperature at which heat is supplied to the system or with a decrease in the average temperature at which heat is rejected from the system.*

The source and sink temperatures that can be used in practice are not without limits, however. The highest temperature in the cycle is limited by the maximum temperature that the components of the heat engine, such as the piston or the turbine blades, can withstand. The lowest temperature is limited by the temperature of the cooling medium utilized in the cycle such as a lake, a river, or the atmospheric air.

EXAMPLE 1 Derivation of the Efficiency of the Carnot Cycle

Show that the thermal efficiency of a Carnot cycle operating between the temperature limits of T_H and T_L is solely a function of these two temperatures and is given by Eq. 2.

Solution It is to be shown that the efficiency of a Carnot cycle depends on the source and sink temperatures alone.

6 | Fundamentals of Thermal-Fluid Sciences

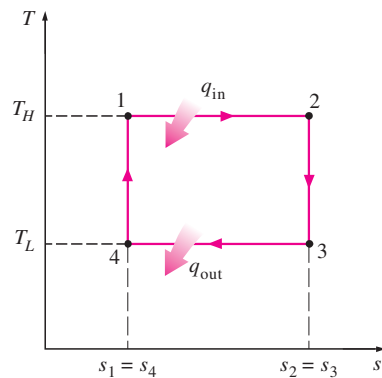

FIGURE 8

T-s diagram for Example 1.

Analysis The *T-s* diagram of a Carnot cycle is redrawn in Fig. 8. All four processes that comprise the Carnot cycle are reversible, and thus the area under each process curve represents the heat transfer for that process. Heat is transferred to the system during process 1-2 and rejected during process 3-4. Therefore, the amount of heat input and heat output for the cycle can be expressed as

$$q_{\text{in}} = T_H(s_2 - s_1) \quad \text{and} \quad q_{\text{out}} = T_L(s_3 - s_4) = T_L(s_2 - s_1)$$

since processes 2-3 and 4-1 are isentropic, and thus $s_2 = s_3$ and $s_4 = s_1$. Substituting these into Eq. 1, we see that the thermal efficiency of a Carnot cycle is

$$\eta_{\text{th}} = \frac{w_{\text{net}}}{q_{\text{in}}} = 1 - \frac{q_{\text{out}}}{q_{\text{in}}} = 1 - \frac{T_L(s_2 - s_1)}{T_H(s_2 - s_1)} = 1 - \frac{T_L}{T_H}$$

Discussion Notice that the thermal efficiency of a Carnot cycle is independent of the type of the working fluid used (an ideal gas, steam, etc.) or whether the cycle is executed in a closed or steady-flow system.

3 ■ AIR-STANDARD ASSUMPTIONS

In gas power cycles, the working fluid remains a gas throughout the entire cycle. Spark-ignition engines, diesel engines, and conventional gas turbines are familiar examples of devices that operate on gas cycles. In all these engines, energy is provided by burning a fuel within the system boundaries. That is, they are *internal combustion engines*. Because of this combustion process, the composition of the working fluid changes from air and fuel to combustion products during the course of the cycle. However, considering that air is predominantly nitrogen that undergoes hardly any chemical reactions in the combustion chamber, the working fluid closely resembles air at all times.

Even though internal combustion engines operate on a mechanical cycle (the piston returns to its starting position at the end of each revolution), the working fluid does not undergo a complete thermodynamic cycle. It is thrown out of the engine at some point in the cycle (as exhaust gases) instead of being returned to the initial state. Working on an open cycle is the characteristic of all internal combustion engines.

The actual gas power cycles are rather complex. To reduce the analysis to a manageable level, we utilize the following approximations, commonly known as the **air-standard assumptions**:

1. The working fluid is air, which continuously circulates in a closed loop and always behaves as an ideal gas.
2. All the processes that make up the cycle are internally reversible.
3. The combustion process is replaced by a heat-addition process from an external source (Fig. 9).
4. The exhaust process is replaced by a heat-rejection process that restores the working fluid to its initial state.

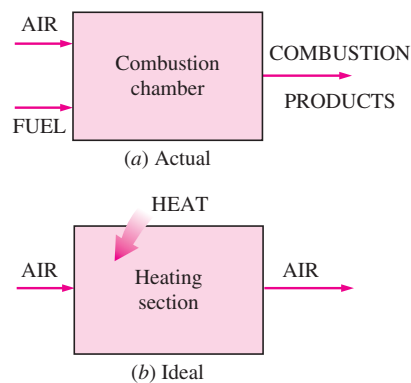

FIGURE 9

The combustion process is replaced by a heat-addition process in ideal cycles.

Another assumption that is often utilized to simplify the analysis even more is that air has constant specific heats whose values are determined at

room temperature (25°C, or 77°F). When this assumption is utilized, the air-standard assumptions are called the **cold-air-standard assumptions**. A cycle for which the air-standard assumptions are applicable is frequently referred to as an **air-standard cycle**.

The air-standard assumptions previously stated provide considerable simplification in the analysis without significantly deviating from the actual cycles. This simplified model enables us to study qualitatively the influence of major parameters on the performance of the actual engines.

4 ■ AN OVERVIEW OF RECIPROCATING ENGINES

Despite its simplicity, the reciprocating engine (basically a piston–cylinder device) is one of the rare inventions that has proved to be very versatile and to have a wide range of applications. It is the powerhouse of the vast majority of automobiles, trucks, light aircraft, ships, and electric power generators, as well as many other devices.

The basic components of a reciprocating engine are shown in Fig. 10. The piston reciprocates in the cylinder between two fixed positions called the **top dead center (TDC)**—the position of the piston when it forms the smallest volume in the cylinder—and the **bottom dead center (BDC)**—the position of the piston when it forms the largest volume in the cylinder. The distance between the TDC and the BDC is the largest distance that the piston can travel in one direction, and it is called the **stroke** of the engine. The diameter of the piston is called the **bore**. The air or air–fuel mixture is drawn into the cylinder through the **intake valve**, and the combustion products are expelled from the cylinder through the **exhaust valve**.

The minimum volume formed in the cylinder when the piston is at TDC is called the **clearance volume** (Fig. 11). The volume displaced by the piston as it moves between TDC and BDC is called the **displacement volume**. The ratio of the maximum volume formed in the cylinder to the minimum (clearance) volume is called the **compression ratio** r of the engine:

$$r = \frac{V_{\max}}{V_{\min}} = \frac{V_{\text{BDC}}}{V_{\text{TDC}}} \quad (3)$$

Notice that the compression ratio is a *volume ratio* and should not be confused with the pressure ratio.

Another term frequently used in conjunction with reciprocating engines is the **mean effective pressure (MEP)**. It is a fictitious pressure that, if it acted on the piston during the entire power stroke, would produce the same amount of net work as that produced during the actual cycle (Fig. 12). That is,

$$W_{\text{net}} = \text{MEP} \times \text{Piston area} \times \text{Stroke} = \text{MEP} \times \text{Displacement volume}$$

or

$$\text{MEP} = \frac{W_{\text{net}}}{V_{\max} - V_{\min}} = \frac{W_{\text{net}}}{V_{\max} - V_{\min}} \quad (\text{kPa}) \quad (4)$$

The mean effective pressure can be used as a parameter to compare the performances of reciprocating engines of equal size. The engine with a larger value of MEP delivers more net work per cycle and thus performs better.

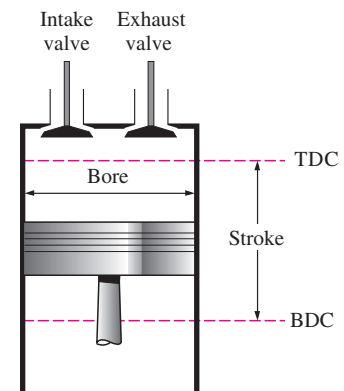

FIGURE 10
Nomenclature for reciprocating engines.

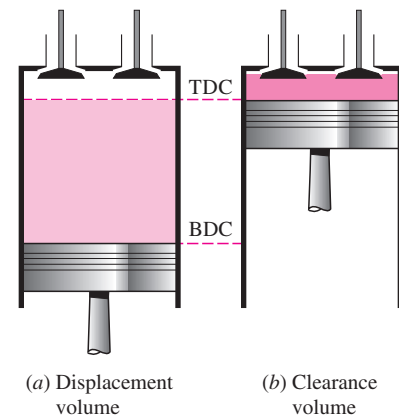

FIGURE 11
Displacement and clearance volumes of a reciprocating engine.

8 | Fundamentals of Thermal-Fluid Sciences

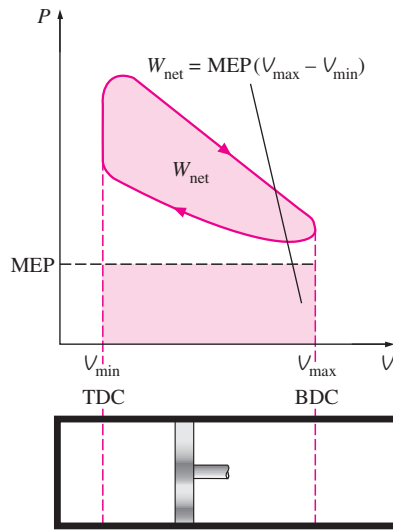

FIGURE 12

The net work output of a cycle is equivalent to the product of the mean effective pressure and the displacement volume.

Reciprocating engines are classified as **spark-ignition (SI) engines** or **compression-ignition (CI) engines**, depending on how the combustion process in the cylinder is initiated. In SI engines, the combustion of the air–fuel mixture is initiated by a spark plug. In CI engines, the air–fuel mixture is self-ignited as a result of compressing the mixture above its self-ignition temperature. In the next two sections, we discuss the *Otto* and *Diesel cycles*, which are the ideal cycles for the SI and CI reciprocating engines, respectively.

5 ■ OTTO CYCLE: THE IDEAL CYCLE FOR SPARK-IGNITION ENGINES

The Otto cycle is the ideal cycle for spark-ignition reciprocating engines. It is named after Nikolaus A. Otto, who built a successful four-stroke engine in 1876 in Germany using the cycle proposed by Frenchman Beau de Rochas in 1862. In most spark-ignition engines, the piston executes four complete strokes (two mechanical cycles) within the cylinder, and the crankshaft completes two revolutions for each thermodynamic cycle. These engines are called **four-stroke** internal combustion engines. A schematic of each stroke as well as a *P-v* diagram for an actual four-stroke spark-ignition engine is given in Fig. 13(a).

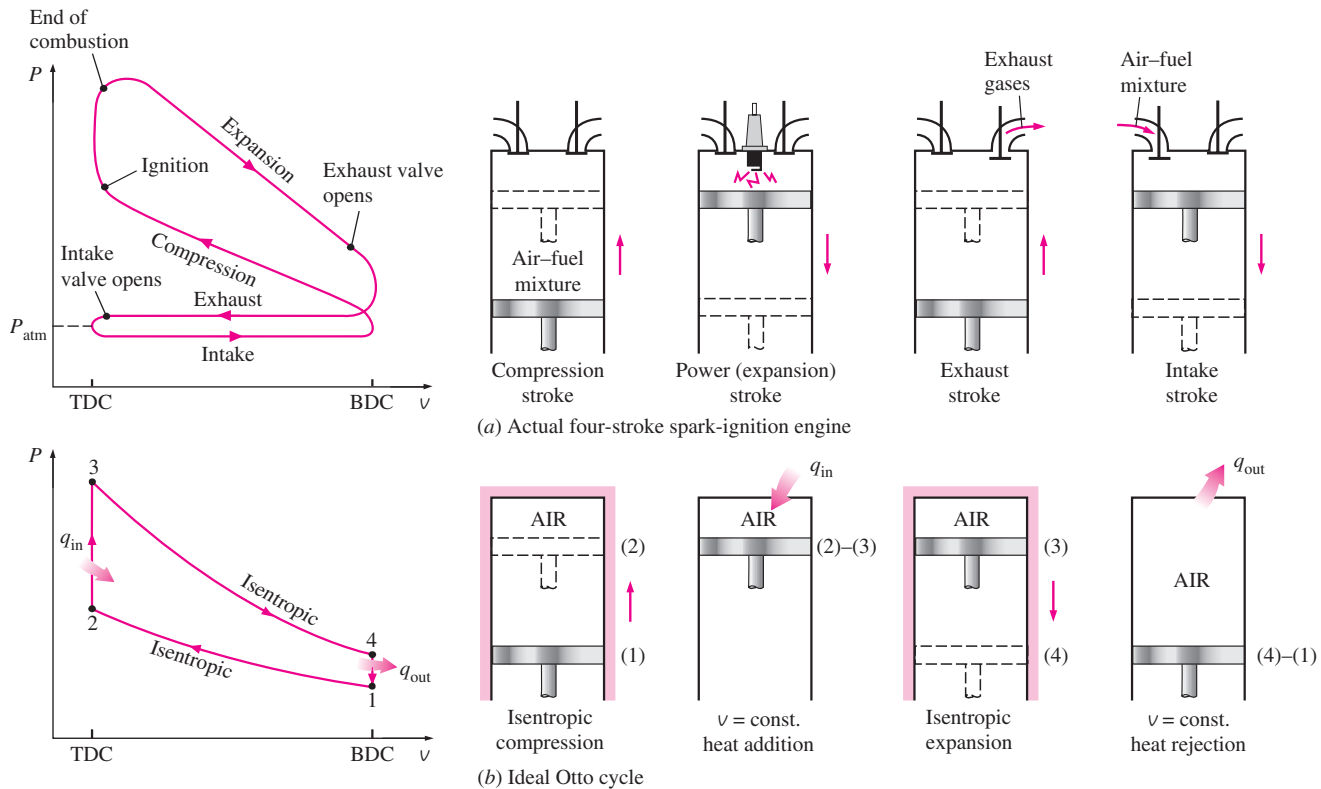

FIGURE 13

Actual and ideal cycles in spark-ignition engines and their *P-v* diagrams.

Initially, both the intake and the exhaust valves are closed, and the piston is at its lowest position (BDC). During the *compression stroke*, the piston moves upward, compressing the air–fuel mixture. Shortly before the piston reaches its highest position (TDC), the spark plug fires and the mixture ignites, increasing the pressure and temperature of the system. The high-pressure gases force the piston down, which in turn forces the crankshaft to rotate, producing a useful work output during the *expansion or power stroke*. At the end of this stroke, the piston is at its lowest position (the completion of the first mechanical cycle), and the cylinder is filled with combustion products. Now the piston moves upward one more time, purging the exhaust gases through the exhaust valve (the *exhaust stroke*), and down a second time, drawing in fresh air–fuel mixture through the intake valve (the *intake stroke*). Notice that the pressure in the cylinder is slightly above the atmospheric value during the exhaust stroke and slightly below during the intake stroke.

In **two-stroke engines**, all four functions described above are executed in just two strokes: the power stroke and the compression stroke. In these engines, the crankcase is sealed, and the outward motion of the piston is used to slightly pressurize the air–fuel mixture in the crankcase, as shown in Fig. 14. Also, the intake and exhaust valves are replaced by openings in the lower portion of the cylinder wall. During the latter part of the power stroke, the piston uncovers first the exhaust port, allowing the exhaust gases to be partially expelled, and then the intake port, allowing the fresh air–fuel mixture to rush in and drive most of the remaining exhaust gases out of the cylinder. This mixture is then compressed as the piston moves upward during the compression stroke and is subsequently ignited by a spark plug.

The two-stroke engines are generally less efficient than their four-stroke counterparts because of the incomplete expulsion of the exhaust gases and the partial expulsion of the fresh air–fuel mixture with the exhaust gases. However, they are relatively simple and inexpensive, and they have high power-to-weight and power-to-volume ratios, which make them suitable for applications requiring small size and weight such as for motorcycles, chain saws, and lawn mowers (Fig. 15).

Advances in several technologies—such as direct fuel injection, stratified charge combustion, and electronic controls—brought about a renewed interest in two-stroke engines that can offer high performance and fuel economy while satisfying the stringent emission requirements. For a given weight and displacement, a well-designed two-stroke engine can provide significantly more power than its four-stroke counterpart because two-stroke engines produce power on every engine revolution instead of every other one. In the new two-stroke engines, the highly atomized fuel spray that is injected into the combustion chamber toward the end of the compression stroke burns much more completely. The fuel is sprayed after the exhaust valve is closed, which prevents unburned fuel from being ejected into the atmosphere. With stratified combustion, the flame that is initiated by igniting a small amount of the rich fuel–air mixture near the spark plug propagates through the combustion chamber filled with a much leaner mixture, and this results in much cleaner combustion. Also, the advances in electronics have made it possible to ensure the optimum operation under varying engine load and speed conditions.

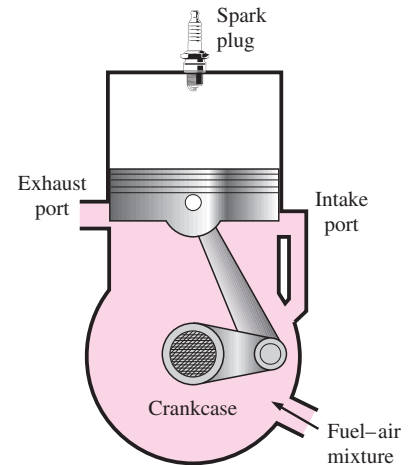

FIGURE 14

Schematic of a two-stroke reciprocating engine.



FIGURE 15

Two-stroke engines are commonly used in motorcycles and lawn mowers.

© Vol. 26/PhotoDisc

10 | Fundamentals of Thermal-Fluid Sciences

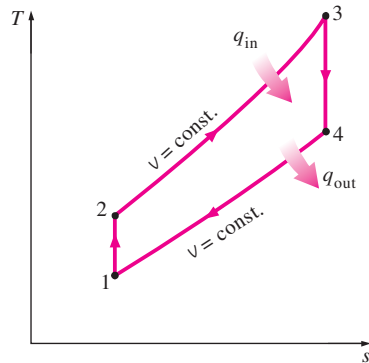

FIGURE 16

T - s diagram of the ideal Otto cycle.

Major car companies have research programs underway on two-stroke engines which are expected to make a comeback in the future.

The thermodynamic analysis of the actual four-stroke or two-stroke cycles described is not a simple task. However, the analysis can be simplified significantly if the air-standard assumptions are utilized. The resulting cycle, which closely resembles the actual operating conditions, is the ideal **Otto cycle**. It consists of four internally reversible processes:

- 1-2 Isentropic compression
- 2-3 Constant-volume heat addition
- 3-4 Isentropic expansion
- 4-1 Constant-volume heat rejection

The execution of the Otto cycle in a piston–cylinder device together with a P - v diagram is illustrated in Fig. 13*b*. The T - s diagram of the Otto cycle is given in Fig. 16.

The Otto cycle is executed in a closed system, and disregarding the changes in kinetic and potential energies, the energy balance for any of the processes is expressed, on a unit-mass basis, as

$$(q_{\text{in}} - q_{\text{out}}) + (w_{\text{in}} - w_{\text{out}}) = \Delta u \quad (\text{kJ/kg}) \quad (5)$$

No work is involved during the two heat transfer processes since both take place at constant volume. Therefore, heat transfer to and from the working fluid can be expressed as

$$q_{\text{in}} = u_3 - u_2 = c_v(T_3 - T_2) \quad (6a)$$

and

$$q_{\text{out}} = u_4 - u_1 = c_v(T_4 - T_1) \quad (6b)$$

Then the thermal efficiency of the ideal Otto cycle under the cold air standard assumptions becomes

$$\eta_{\text{th, Otto}} = \frac{w_{\text{net}}}{q_{\text{in}}} = 1 - \frac{q_{\text{out}}}{q_{\text{in}}} = 1 - \frac{T_4 - T_1}{T_3 - T_2} = 1 - \frac{T_1(T_4/T_1 - 1)}{T_2(T_3/T_2 - 1)}$$

Processes 1-2 and 3-4 are isentropic, and $v_2 = v_3$ and $v_4 = v_1$. Thus,

$$\frac{T_1}{T_2} = \left(\frac{v_2}{v_1}\right)^{k-1} = \left(\frac{v_3}{v_4}\right)^{k-1} = \frac{T_4}{T_3} \quad (7)$$

Substituting these equations into the thermal efficiency relation and simplifying give

$$\eta_{\text{th, Otto}} = 1 - \frac{1}{r^{k-1}} \quad (8)$$

where

$$r = \frac{V_{\text{max}}}{V_{\text{min}}} = \frac{V_1}{V_2} = \frac{v_1}{v_2} \quad (9)$$

is the **compression ratio** and k is the specific heat ratio c_p/c_v .

Equation 8 shows that under the cold-air-standard assumptions, the thermal efficiency of an ideal Otto cycle depends on the compression ratio of the engine and the specific heat ratio of the working fluid. The thermal efficiency of the ideal Otto cycle increases with both the compression ratio and

the specific heat ratio. This is also true for actual spark-ignition internal combustion engines. A plot of thermal efficiency versus the compression ratio is given in Fig. 17 for $k = 1.4$, which is the specific heat ratio value of air at room temperature. For a given compression ratio, the thermal efficiency of an actual spark-ignition engine is less than that of an ideal Otto cycle because of the irreversibilities, such as friction, and other factors such as incomplete combustion.

We can observe from Fig. 17 that the thermal efficiency curve is rather steep at low compression ratios but flattens out starting with a compression ratio value of about 8. Therefore, the increase in thermal efficiency with the compression ratio is not as pronounced at high compression ratios. Also, when high compression ratios are used, the temperature of the air–fuel mixture rises above the autoignition temperature of the fuel (the temperature at which the fuel ignites without the help of a spark) during the combustion process, causing an early and rapid burn of the fuel at some point or points ahead of the flame front, followed by almost instantaneous inflammation of the end gas. This premature ignition of the fuel, called **autoignition**, produces an audible noise, which is called **engine knock**. Autoignition in spark-ignition engines cannot be tolerated because it hurts performance and can cause engine damage. The requirement that autoignition not be allowed places an upper limit on the compression ratios that can be used in spark-ignition internal combustion engines.

Improvement of the thermal efficiency of gasoline engines by utilizing higher compression ratios (up to about 12) without facing the autoignition problem has been made possible by using gasoline blends that have good antiknock characteristics, such as gasoline mixed with tetraethyl lead. Tetraethyl lead had been added to gasoline since the 1920s because it is an inexpensive method of raising the *octane rating*, which is a measure of the engine knock resistance of a fuel. Leaded gasoline, however, has a very undesirable side effect: it forms compounds during the combustion process that are hazardous to health and pollute the environment. In an effort to combat air pollution, the government adopted a policy in the mid-1970s that resulted in the eventual phase-out of leaded gasoline. Unable to use lead, the refiners developed other techniques to improve the antiknock characteristics of gasoline. Most cars made since 1975 have been designed to use unleaded gasoline, and the compression ratios had to be lowered to avoid engine knock. The ready availability of high octane fuels made it possible to raise the compression ratios again in recent years. Also, owing to the improvements in other areas (reduction in overall automobile weight, improved aerodynamic design, etc.), today's cars have better fuel economy and consequently get more miles per gallon of fuel. This is an example of how engineering decisions involve compromises, and efficiency is only one of the considerations in final design.

The second parameter affecting the thermal efficiency of an ideal Otto cycle is the specific heat ratio k . For a given compression ratio, an ideal Otto cycle using a monatomic gas (such as argon or helium, $k = 1.667$) as the working fluid will have the highest thermal efficiency. The specific heat ratio k , and thus the thermal efficiency of the ideal Otto cycle, decreases as the molecules of the working fluid get larger (Fig. 18). At room temperature it is 1.4 for air, 1.3 for carbon dioxide, and 1.2 for ethane. The working

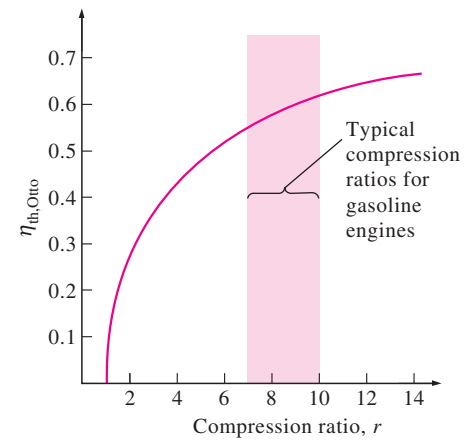

FIGURE 17

Thermal efficiency of the ideal Otto cycle as a function of compression ratio ($k = 1.4$).

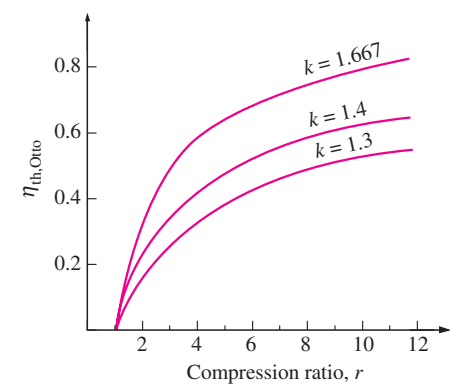

FIGURE 18

The thermal efficiency of the Otto cycle increases with the specific heat ratio k of the working fluid.

12 | Fundamentals of Thermal-Fluid Sciences

fluid in actual engines contains larger molecules such as carbon dioxide, and the specific heat ratio decreases with temperature, which is one of the reasons that the actual cycles have lower thermal efficiencies than the ideal Otto cycle. The thermal efficiencies of actual spark-ignition engines range from about 25 to 30 percent.

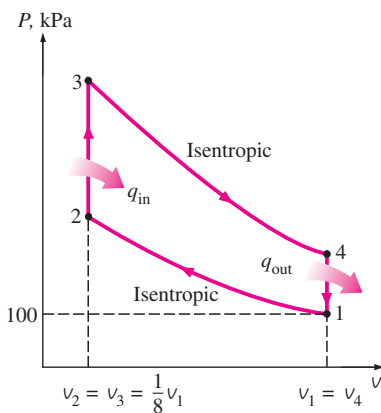

FIGURE 19

P-v diagram for the Otto cycle discussed in Example 2.

EXAMPLE 2 The Ideal Otto Cycle

An ideal Otto cycle has a compression ratio of 8. At the beginning of the compression process, air is at 100 kPa and 17°C, and 800 kJ/kg of heat is transferred to air during the constant-volume heat-addition process. Accounting for the variation of specific heats of air with temperature, determine (a) the maximum temperature and pressure that occur during the cycle, (b) the net work output, (c) the thermal efficiency, and (d) the mean effective pressure for the cycle.

Solution An ideal Otto cycle is considered. The maximum temperature and pressure, the net work output, the thermal efficiency, and the mean effective pressure are to be determined.

Assumptions 1 The air-standard assumptions are applicable. 2 Kinetic and potential energy changes are negligible. 3 The variation of specific heats with temperature is to be accounted for.

Analysis The *P-v* diagram of the ideal Otto cycle described is shown in Fig. 19. We note that the air contained in the cylinder forms a closed system.

(a) The maximum temperature and pressure in an Otto cycle occur at the end of the constant-volume heat-addition process (state 3). But first we need to determine the temperature and pressure of air at the end of the isentropic compression process (state 2), using data from Table A-17:

$$T_1 = 290 \text{ K} \rightarrow u_1 = 206.91 \text{ kJ/kg} \\ v_{r1} = 676.1$$

Process 1-2 (isentropic compression of an ideal gas):

$$\frac{v_{r2}}{v_{r1}} = \frac{v_2}{v_1} = \frac{1}{r} \rightarrow v_{r2} = \frac{v_{r1}}{r} = \frac{676.1}{8} = 84.51 \rightarrow T_2 = 652.4 \text{ K} \\ u_2 = 475.11 \text{ kJ/kg}$$

$$\frac{P_2 v_2}{T_2} = \frac{P_1 v_1}{T_1} \rightarrow P_2 = P_1 \left(\frac{T_2}{T_1} \right) \left(\frac{v_1}{v_2} \right) \\ = (100 \text{ kPa}) \left(\frac{652.4 \text{ K}}{290 \text{ K}} \right) (8) = 1799.7 \text{ kPa}$$

Process 2-3 (constant-volume heat addition):

$$q_{\text{in}} = u_3 - u_2 \\ 800 \text{ kJ/kg} = u_3 - 475.11 \text{ kJ/kg} \\ u_3 = 1275.11 \text{ kJ/kg} \rightarrow T_3 = \mathbf{1575.1 \text{ K}} \\ v_{r3} = 6.108$$

$$\begin{aligned}\frac{P_3 v_3}{T_3} &= \frac{P_2 v_2}{T_2} \rightarrow P_3 = P_2 \left(\frac{T_3}{T_2} \right) \left(\frac{v_2}{v_3} \right) \\ &= (1.7997 \text{ MPa}) \left(\frac{1575.1 \text{ K}}{652.4 \text{ K}} \right) (1) = \mathbf{4.345 \text{ MPa}}\end{aligned}$$

(b) The net work output for the cycle is determined either by finding the boundary ($P dV$) work involved in each process by integration and adding them or by finding the net heat transfer that is equivalent to the net work done during the cycle. We take the latter approach. However, first we need to find the internal energy of the air at state 4:

Process 3-4 (isentropic expansion of an ideal gas):

$$\begin{aligned}\frac{v_{r4}}{v_{r3}} &= \frac{v_4}{v_3} = r \rightarrow v_{r4} = r v_{r3} = (8)(6.108) = 48.864 \rightarrow T_4 = 795.6 \text{ K} \\ u_4 &= 588.74 \text{ kJ/kg}\end{aligned}$$

Process 4-1 (constant-volume heat rejection):

$$\begin{aligned}-q_{\text{out}} &= u_1 - u_4 \rightarrow q_{\text{out}} = u_4 - u_1 \\ q_{\text{out}} &= 588.74 - 206.91 = 381.83 \text{ kJ/kg}\end{aligned}$$

Thus,

$$w_{\text{net}} = q_{\text{net}} = q_{\text{in}} - q_{\text{out}} = 800 - 381.83 = \mathbf{418.17 \text{ kJ/kg}}$$

(c) The thermal efficiency of the cycle is determined from its definition:

$$\eta_{\text{th}} = \frac{w_{\text{net}}}{q_{\text{in}}} = \frac{418.17 \text{ kJ/kg}}{800 \text{ kJ/kg}} = \mathbf{0.523 \text{ or } 52.3\%}$$

Under the cold-air-standard assumptions (constant specific heat values at room temperature), the thermal efficiency would be (Eq. 8)

$$\eta_{\text{th, Otto}} = 1 - \frac{1}{r^{k-1}} = 1 - r^{1-k} = 1 - (8)^{1-1.4} = 0.565 \text{ or } 56.5\%$$

which is considerably different from the value obtained above. Therefore, care should be exercised in utilizing the cold-air-standard assumptions.

(d) The mean effective pressure is determined from its definition, Eq. 4:

$$\text{MEP} = \frac{w_{\text{net}}}{v_1 - v_2} = \frac{w_{\text{net}}}{v_1 - v_1/r} = \frac{w_{\text{net}}}{v_1(1 - 1/r)}$$

where

$$v_1 = \frac{RT_1}{P_1} = \frac{(0.287 \text{ kPa} \cdot \text{m}^3/\text{kg} \cdot \text{K})(290 \text{ K})}{100 \text{ kPa}} = 0.832 \text{ m}^3/\text{kg}$$

Thus,

$$\text{MEP} = \frac{418.17 \text{ kJ/kg}}{(0.832 \text{ m}^3/\text{kg})(1 - \frac{1}{8})} \left(\frac{1 \text{ kPa} \cdot \text{m}^3}{1 \text{ kJ}} \right) = \mathbf{574 \text{ kPa}}$$

Discussion Note that a constant pressure of 574 kPa during the power stroke would produce the same net work output as the entire cycle.

14 | Fundamentals of Thermal-Fluid Sciences

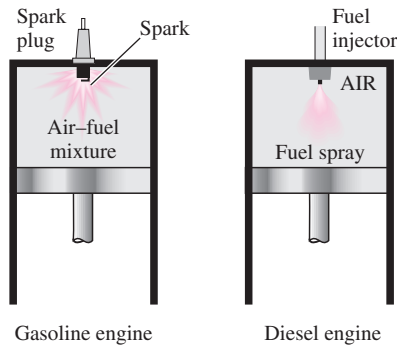

FIGURE 20

In diesel engines, the spark plug is replaced by a fuel injector, and only air is compressed during the compression process.

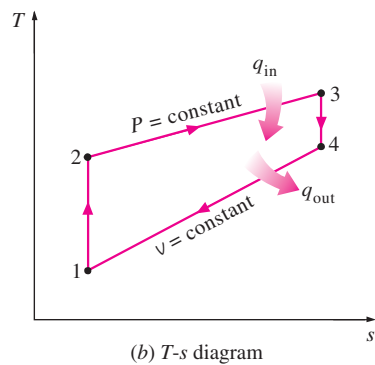
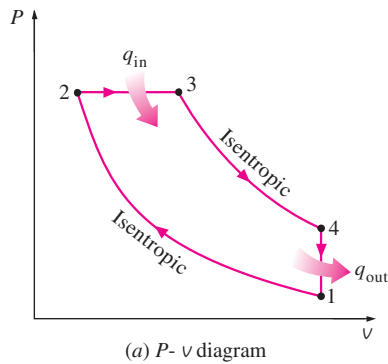

FIGURE 21

T - s and P - v diagrams for the ideal Diesel cycle.

6 ■ DIESEL CYCLE: THE IDEAL CYCLE FOR COMPRESSION-IGNITION ENGINES

The Diesel cycle is the ideal cycle for CI reciprocating engines. The CI engine, first proposed by Rudolph Diesel in the 1890s, is very similar to the SI engine discussed in the last section, differing mainly in the method of initiating combustion. In spark-ignition engines (also known as *gasoline engines*), the air–fuel mixture is compressed to a temperature that is below the autoignition temperature of the fuel, and the combustion process is initiated by firing a spark plug. In CI engines (also known as *diesel engines*), the air is compressed to a temperature that is above the autoignition temperature of the fuel, and combustion starts on contact as the fuel is injected into this hot air. Therefore, the spark plug and carburetor are replaced by a fuel injector in diesel engines (Fig. 20).

In gasoline engines, a mixture of air and fuel is compressed during the compression stroke, and the compression ratios are limited by the onset of autoignition or engine knock. In diesel engines, only air is compressed during the compression stroke, eliminating the possibility of autoignition. Therefore, diesel engines can be designed to operate at much higher compression ratios, typically between 12 and 24. Not having to deal with the problem of autoignition has another benefit: many of the stringent requirements placed on the gasoline can now be removed, and fuels that are less refined (thus less expensive) can be used in diesel engines.

The fuel injection process in diesel engines starts when the piston approaches TDC and continues during the first part of the power stroke. Therefore, the combustion process in these engines takes place over a longer interval. Because of this longer duration, the combustion process in the ideal Diesel cycle is approximated as a constant-pressure heat-addition process. In fact, this is the only process where the Otto and the Diesel cycles differ. The remaining three processes are the same for both ideal cycles. That is, process 1–2 is isentropic compression, 3–4 is isentropic expansion, and 4–1 is constant-volume heat rejection. The similarity between the two cycles is also apparent from the P - v and T - s diagrams of the Diesel cycle, shown in Fig. 21.

Noting that the Diesel cycle is executed in a piston–cylinder device, which forms a closed system, the amount of heat transferred to the working fluid at constant pressure and rejected from it at constant volume can be expressed as

$$\begin{aligned} q_{\text{in}} - w_{b,\text{out}} &= u_3 - u_2 \rightarrow q_{\text{in}} = P_2(v_3 - v_2) + (u_3 - u_2) \\ &= h_3 - h_2 = c_p(T_3 - T_2) \end{aligned} \quad (10a)$$

and

$$-q_{\text{out}} = u_1 - u_4 \rightarrow q_{\text{out}} = u_4 - u_1 = c_v(T_4 - T_1) \quad (10b)$$

Then the thermal efficiency of the ideal Diesel cycle under the cold-air-standard assumptions becomes

$$\eta_{\text{th,Diesel}} = \frac{w_{\text{net}}}{q_{\text{in}}} = 1 - \frac{q_{\text{out}}}{q_{\text{in}}} = 1 - \frac{T_4 - T_1}{k(T_3 - T_2)} = 1 - \frac{T_1(T_4/T_1 - 1)}{kT_2(T_3/T_2 - 1)}$$

We now define a new quantity, the **cutoff ratio** r_c , as the ratio of the cylinder volumes after and before the combustion process:

$$r_c = \frac{V_3}{V_2} = \frac{v_3}{v_2} \quad (11)$$

Utilizing this definition and the isentropic ideal-gas relations for processes 1-2 and 3-4, we see that the thermal efficiency relation reduces to

$$\eta_{\text{th,Diesel}} = 1 - \frac{1}{r^{k-1}} \left[\frac{r_c^k - 1}{k(r_c - 1)} \right] \quad (12)$$

where r is the compression ratio defined by Eq. 9. Looking at Eq. 12 carefully, one would notice that under the cold-air-standard assumptions, the efficiency of a Diesel cycle differs from the efficiency of an Otto cycle by the quantity in the brackets. This quantity is always greater than 1. Therefore,

$$\eta_{\text{th,Otto}} > \eta_{\text{th,Diesel}} \quad (13)$$

when both cycles operate on the same compression ratio. Also, as the cutoff ratio decreases, the efficiency of the Diesel cycle increases (Fig. 22). For the limiting case of $r_c = 1$, the quantity in the brackets becomes unity (can you prove it?), and the efficiencies of the Otto and Diesel cycles become identical. Remember, though, that diesel engines operate at much higher compression ratios and thus are usually more efficient than the spark-ignition (gasoline) engines. The diesel engines also burn the fuel more completely since they usually operate at lower revolutions per minute and the air-fuel mass ratio is much higher than spark-ignition engines. Thermal efficiencies of large diesel engines range from about 35 to 40 percent.

The higher efficiency and lower fuel costs of diesel engines make them attractive in applications requiring relatively large amounts of power, such as in locomotive engines, emergency power generation units, large ships, and heavy trucks. As an example of how large a diesel engine can be, a 12-cylinder diesel engine built in 1964 by the Fiat Corporation of Italy had a normal power output of 25,200 hp (18.8 MW) at 122 rpm, a cylinder bore of 90 cm, and a stroke of 91 cm.

Approximating the combustion process in internal combustion engines as a constant-volume or a constant-pressure heat-addition process is overly simplistic and not quite realistic. Probably a better (but slightly more complex) approach would be to model the combustion process in both gasoline and diesel engines as a combination of two heat-transfer processes, one at constant volume and the other at constant pressure. The ideal cycle based on this concept is called the **dual cycle**, and a P - v diagram for it is given in Fig. 23. The relative amounts of heat transferred during each process can be adjusted to approximate the actual cycle more closely. Note that both the Otto and the Diesel cycles can be obtained as special cases of the dual cycle.

EXAMPLE 3 The Ideal Diesel Cycle

An ideal Diesel cycle with air as the working fluid has a compression ratio of 18 and a cutoff ratio of 2. At the beginning of the compression process, the working fluid is at 14.7 psia, 80°F, and 117 in³. Utilizing the cold-air-standard assumptions, determine (a) the temperature and pressure of air at

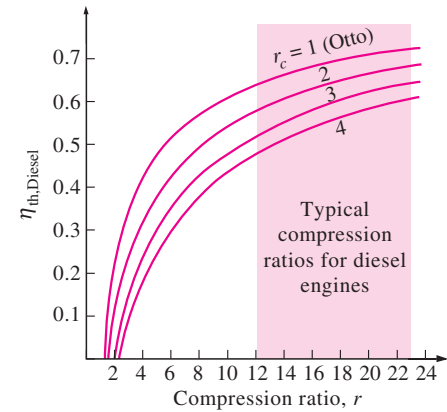

FIGURE 22

Thermal efficiency of the ideal Diesel cycle as a function of compression and cutoff ratios ($k = 1.4$).

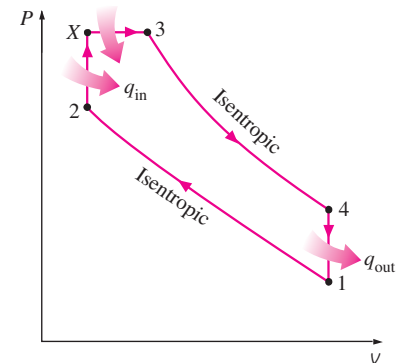

FIGURE 23

P - v diagram of an ideal dual cycle.

16 | Fundamentals of Thermal-Fluid Sciences

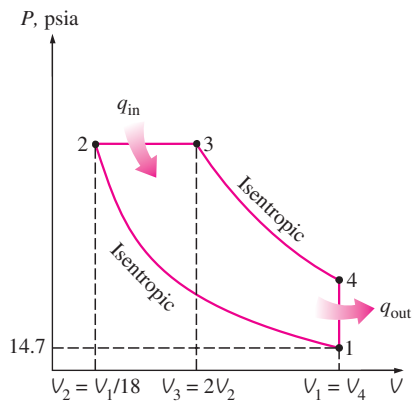

FIGURE 24

P-*V* diagram for the ideal Diesel cycle discussed in Example 3.

the end of each process, (b) the net work output and the thermal efficiency, and (c) the mean effective pressure.

Solution An ideal Diesel cycle is considered. The temperature and pressure at the end of each process, the net work output, the thermal efficiency, and the mean effective pressure are to be determined.

Assumptions 1 The cold-air-standard assumptions are applicable and thus air can be assumed to have constant specific heats at room temperature. 2 Kinetic and potential energy changes are negligible.

Properties The gas constant of air is $R = 0.3704 \text{ psia} \cdot \text{ft}^3/\text{lbm} \cdot \text{R}$ and its other properties at room temperature are $c_p = 0.240 \text{ Btu}/\text{lbm} \cdot \text{R}$, $c_v = 0.171 \text{ Btu}/\text{lbm} \cdot \text{R}$, and $k = 1.4$ (Table A-2Ea).

Analysis The *P*-*V* diagram of the ideal Diesel cycle described is shown in Fig. 24. We note that the air contained in the cylinder forms a closed system.

(a) The temperature and pressure values at the end of each process can be determined by utilizing the ideal-gas isentropic relations for processes 1-2 and 3-4. But first we determine the volumes at the end of each process from the definitions of the compression ratio and the cutoff ratio:

$$V_2 = \frac{V_1}{r} = \frac{117 \text{ in}^3}{18} = 6.5 \text{ in}^3$$

$$V_3 = r_c V_2 = (2)(6.5 \text{ in}^3) = 13 \text{ in}^3$$

$$V_4 = V_1 = 117 \text{ in}^3$$

Process 1-2 (isentropic compression of an ideal gas, constant specific heats):

$$T_2 = T_1 \left(\frac{V_1}{V_2} \right)^{k-1} = (540 \text{ R})(18)^{1.4-1} = \mathbf{1716 \text{ R}}$$

$$P_2 = P_1 \left(\frac{V_1}{V_2} \right)^k = (14.7 \text{ psia})(18)^{1.4} = \mathbf{841 \text{ psia}}$$

Process 2-3 (constant-pressure heat addition to an ideal gas):

$$P_3 = P_2 = \mathbf{841 \text{ psia}}$$

$$\frac{P_2 V_2}{T_2} = \frac{P_3 V_3}{T_3} \rightarrow T_3 = T_2 \left(\frac{V_3}{V_2} \right) = (1716 \text{ R})(2) = \mathbf{3432 \text{ R}}$$

Process 3-4 (isentropic expansion of an ideal gas, constant specific heats):

$$T_4 = T_3 \left(\frac{V_3}{V_4} \right)^{k-1} = (3432 \text{ R}) \left(\frac{13 \text{ in}^3}{117 \text{ in}^3} \right)^{1.4-1} = \mathbf{1425 \text{ R}}$$

$$P_4 = P_3 \left(\frac{V_3}{V_4} \right)^k = (841 \text{ psia}) \left(\frac{13 \text{ in}^3}{117 \text{ in}^3} \right)^{1.4} = \mathbf{38.8 \text{ psia}}$$

(b) The net work for a cycle is equivalent to the net heat transfer. But first we find the mass of air:

$$m = \frac{P_1 V_1}{RT_1} = \frac{(14.7 \text{ psia})(117 \text{ in}^3)}{(0.3704 \text{ psia} \cdot \text{ft}^3/\text{lbm} \cdot \text{R})(540 \text{ R})} \left(\frac{1 \text{ ft}^3}{1728 \text{ in}^3} \right) = 0.00498 \text{ lbm}$$

Process 2-3 is a constant-pressure heat-addition process, for which the boundary work and Δu terms can be combined into Δh . Thus,

$$\begin{aligned} Q_{\text{in}} &= m(h_3 - h_2) = mc_p(T_3 - T_2) \\ &= (0.00498 \text{ lbm})(0.240 \text{ Btu/lbm} \cdot \text{R})[(3432 - 1716) \text{ R}] \\ &= 2.051 \text{ Btu} \end{aligned}$$

Process 4-1 is a constant-volume heat-rejection process (it involves no work interactions), and the amount of heat rejected is

$$\begin{aligned} Q_{\text{out}} &= m(u_4 - u_1) = mc_v(T_4 - T_1) \\ &= (0.00498 \text{ lbm})(0.171 \text{ Btu/lbm} \cdot \text{R})[(1425 - 540) \text{ R}] \\ &= 0.754 \text{ Btu} \end{aligned}$$

Thus,

$$W_{\text{net}} = Q_{\text{in}} - Q_{\text{out}} = 2.051 - 0.754 = \mathbf{1.297 \text{ Btu}}$$

Then the thermal efficiency becomes

$$\eta_{\text{th}} = \frac{W_{\text{net}}}{Q_{\text{in}}} = \frac{1.297 \text{ Btu}}{2.051 \text{ Btu}} = \mathbf{0.632 \text{ or } 63.2\%}$$

The thermal efficiency of this Diesel cycle under the cold-air-standard assumptions could also be determined from Eq. 12.

(c) The mean effective pressure is determined from its definition, Eq. 4:

$$\begin{aligned} \text{MEP} &= \frac{W_{\text{net}}}{V_{\text{max}} - V_{\text{min}}} = \frac{W_{\text{net}}}{V_1 - V_2} = \frac{1.297 \text{ Btu}}{(117 - 6.5) \text{ in}^3} \left(\frac{778.17 \text{ lbf} \cdot \text{ft}}{1 \text{ Btu}} \right) \left(\frac{12 \text{ in.}}{1 \text{ ft}} \right) \\ &= \mathbf{110 \text{ psia}} \end{aligned}$$

Discussion Note that a constant pressure of 110 psia during the power stroke would produce the same net work output as the entire Diesel cycle.

7 ■ BRAYTON CYCLE: THE IDEAL CYCLE FOR GAS-TURBINE ENGINES

The Brayton cycle was first proposed by George Brayton for use in the reciprocating oil-burning engine that he developed around 1870. Today, it is used for gas turbines only where both the compression and expansion processes take place in rotating machinery. Gas turbines usually operate on an *open cycle*, as shown in Fig. 25. Fresh air at ambient conditions is drawn into the compressor, where its temperature and pressure are raised. The high-pressure air proceeds into the combustion chamber, where the fuel is burned at constant pressure. The resulting high-temperature gases then enter the turbine, where they expand to the atmospheric pressure while producing power. The exhaust gases leaving the turbine are thrown out (not recirculated), causing the cycle to be classified as an open cycle.

The open gas-turbine cycle described above can be modeled as a *closed cycle*, as shown in Fig. 26, by utilizing the air-standard assumptions. Here the compression and expansion processes remain the same, but the combustion process is replaced by a constant-pressure heat-addition process from

18 | Fundamentals of Thermal-Fluid Sciences

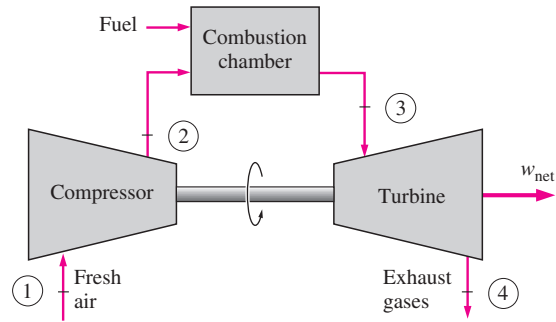

FIGURE 25
An open-cycle gas-turbine engine.

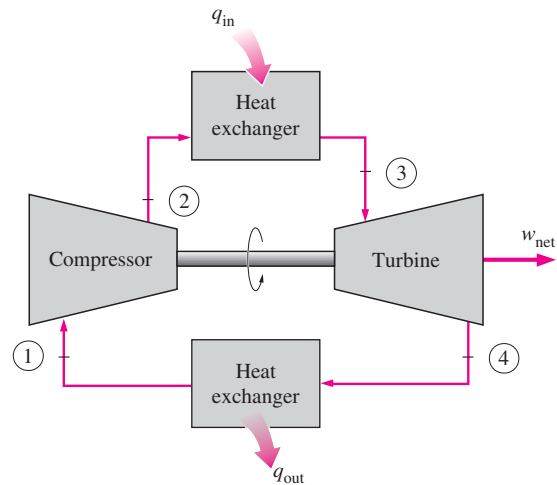

FIGURE 26
A closed-cycle gas-turbine engine.

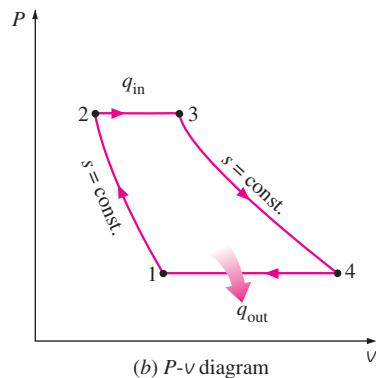
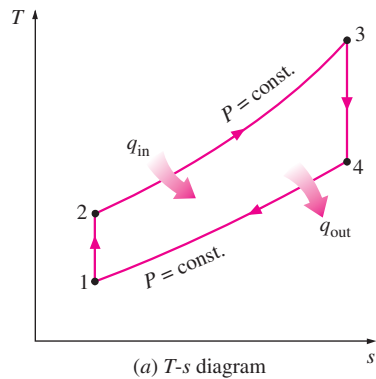

FIGURE 27
 T - s and P - v diagrams for the ideal Brayton cycle.

an external source, and the exhaust process is replaced by a constant-pressure heat-rejection process to the ambient air. The ideal cycle that the working fluid undergoes in this closed loop is the **Brayton cycle**, which is made up of four internally reversible processes:

- 1-2 Isentropic compression (in a compressor)
- 2-3 Constant-pressure heat addition
- 3-4 Isentropic expansion (in a turbine)
- 4-1 Constant-pressure heat rejection

The T - s and P - v diagrams of an ideal Brayton cycle are shown in Fig. 27. Notice that all four processes of the Brayton cycle are executed in steady-flow devices; thus, they should be analyzed as steady-flow processes. When the changes in kinetic and potential energies are neglected, the energy balance for a steady-flow process can be expressed, on a unit-mass basis, as

$$(q_{in} - q_{out}) + (w_{in} - w_{out}) = h_{exit} - h_{inlet} \quad (14)$$

Therefore, heat transfers to and from the working fluid are

$$q_{in} = h_3 - h_2 = c_p(T_3 - T_2) \quad (15a)$$

and

$$q_{out} = h_4 - h_1 = c_p(T_4 - T_1) \quad (15b)$$

Then the thermal efficiency of the ideal Brayton cycle under the cold-air-standard assumptions becomes

$$\eta_{th, \text{Brayton}} = \frac{w_{net}}{q_{in}} = 1 - \frac{q_{out}}{q_{in}} = 1 - \frac{c_p(T_4 - T_1)}{c_p(T_3 - T_2)} = 1 - \frac{T_1(T_4/T_1 - 1)}{T_2(T_3/T_2 - 1)}$$

Processes 1-2 and 3-4 are isentropic, and $P_2 = P_3$ and $P_4 = P_1$. Thus,

$$\frac{T_2}{T_1} = \left(\frac{P_2}{P_1}\right)^{(k-1)/k} = \left(\frac{P_3}{P_4}\right)^{(k-1)/k} = \frac{T_3}{T_4}$$

Substituting these equations into the thermal efficiency relation and simplifying give

$$\eta_{\text{th,Brayton}} = 1 - \frac{1}{r_p^{(k-1)/k}} \quad (16)$$

where

$$r_p = \frac{P_2}{P_1} \quad (17)$$

is the **pressure ratio** and k is the specific heat ratio. Equation 16 shows that under the cold-air-standard assumptions, the thermal efficiency of an ideal Brayton cycle depends on the pressure ratio of the gas turbine and the specific heat ratio of the working fluid. The thermal efficiency increases with both of these parameters, which is also the case for actual gas turbines. A plot of thermal efficiency versus the pressure ratio is given in Fig. 28 for $k = 1.4$, which is the specific-heat-ratio value of air at room temperature.

The highest temperature in the cycle occurs at the end of the combustion process (state 3), and it is limited by the maximum temperature that the turbine blades can withstand. This also limits the pressure ratios that can be used in the cycle. For a fixed turbine inlet temperature T_3 , the net work output per cycle increases with the pressure ratio, reaches a maximum, and then starts to decrease, as shown in Fig. 29. Therefore, there should be a compromise between the pressure ratio (thus the thermal efficiency) and the net work output. With less work output per cycle, a larger mass flow rate (thus a larger system) is needed to maintain the same power output, which may not be economical. In most common designs, the pressure ratio of gas turbines ranges from about 11 to 16.

The air in gas turbines performs two important functions: It supplies the necessary oxidant for the combustion of the fuel, and it serves as a coolant to keep the temperature of various components within safe limits. The second function is accomplished by drawing in more air than is needed for the complete combustion of the fuel. In gas turbines, an air–fuel mass ratio of 50 or above is not uncommon. Therefore, in a cycle analysis, treating the combustion gases as air does not cause any appreciable error. Also, the mass flow rate through the turbine is greater than that through the compressor, the difference being equal to the mass flow rate of the fuel. Thus, assuming a constant mass flow rate throughout the cycle yields conservative results for open-loop gas-turbine engines.

The two major application areas of gas-turbine engines are *aircraft propulsion* and *electric power generation*. When it is used for aircraft propulsion, the gas turbine produces just enough power to drive the compressor and a small generator to power the auxiliary equipment. The high-velocity exhaust gases are responsible for producing the necessary thrust to propel the aircraft. Gas turbines are also used as stationary power plants to generate electricity as stand-alone units or in conjunction with steam power plants on the high-temperature side. In these plants, the exhaust gases of the gas turbine serve as the heat source for the steam. The gas-turbine cycle can also be executed as a closed cycle for use in nuclear power plants. This time the working fluid is not limited to air, and a gas with more desirable characteristics (such as helium) can be used.

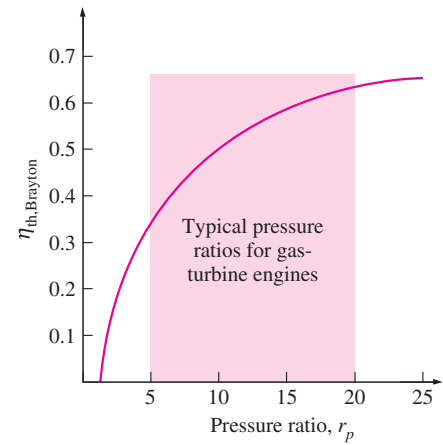

FIGURE 28

Thermal efficiency of the ideal Brayton cycle as a function of the pressure ratio.

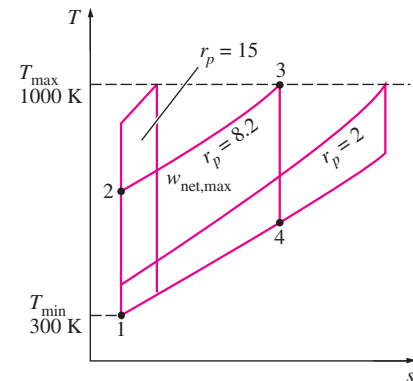

FIGURE 29

For fixed values of T_{\min} and T_{\max} , the net work of the Brayton cycle first increases with the pressure ratio, then reaches a maximum at $r_p = (T_{\max}/T_{\min})^{k/[2(k-1)]}$, and finally decreases.

The majority of the Western world's naval fleets already use gas-turbine engines for propulsion and electric power generation. The General Electric LM2500 gas turbines used to power ships have a simple-cycle thermal efficiency of 37 percent. The General Electric WR-21 gas turbines equipped with intercooling and regeneration have a thermal efficiency of 43 percent and produce 21.6 MW (29,040 hp). The regeneration also reduces the exhaust temperature from 600°C (1100°F) to 350°C (650°F). Air is compressed to 3 atm before it enters the intercooler. Compared to steam-turbine and diesel-propulsion systems, the gas turbine offers greater power for a given size and weight, high reliability, long life, and more convenient operation. The engine start-up time has been reduced from 4 h required for a typical steam-propulsion system to less than 2 min for a gas turbine. Many modern marine propulsion systems use gas turbines together with diesel engines because of the high fuel consumption of simple-cycle gas-turbine engines. In combined diesel and gas-turbine systems, diesel is used to provide for efficient low-power and cruise operation, and gas turbine is used when high speeds are needed.

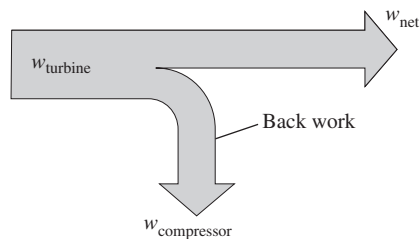

FIGURE 30

The fraction of the turbine work used to drive the compressor is called the back work ratio.

In gas-turbine power plants, the ratio of the compressor work to the turbine work, called the **back work ratio**, is very high (Fig. 30). Usually more than one-half of the turbine work output is used to drive the compressor. The situation is even worse when the isentropic efficiencies of the compressor and the turbine are low. This is quite in contrast to steam power plants, where the back work ratio is only a few percent. This is not surprising, however, since a liquid is compressed in steam power plants instead of a gas, and the steady-flow work is proportional to the specific volume of the working fluid.

A power plant with a high back work ratio requires a larger turbine to provide the additional power requirements of the compressor. Therefore, the turbines used in gas-turbine power plants are larger than those used in steam power plants of the same net power output.

Development of Gas Turbines

The gas turbine has experienced phenomenal progress and growth since its first successful development in the 1930s. The early gas turbines built in the 1940s and even 1950s had simple-cycle efficiencies of about 17 percent because of the low compressor and turbine efficiencies and low turbine inlet temperatures due to metallurgical limitations of those times. Therefore, gas turbines found only limited use despite their versatility and their ability to burn a variety of fuels. The efforts to improve the cycle efficiency concentrated in three areas:

1. **Increasing the turbine inlet (or firing) temperatures** This has been the primary approach taken to improve gas-turbine efficiency. The turbine inlet temperatures have increased steadily from about 540°C (1000°F) in the 1940s to 1425°C (2600°F) and even higher today. These increases were made possible by the development of new materials and the innovative cooling techniques for the critical components such as coating the turbine blades with ceramic layers and cooling the blades with the discharge air from the compressor. Maintaining high turbine inlet temperatures with an air-cooling technique requires the combustion temperature to be higher to compensate for the cooling effect of the cooling air. However, higher combustion temper-

atures increase the amount of nitrogen oxides (NO_x), which are responsible for the formation of ozone at ground level and smog. Using steam as the coolant allowed an increase in the turbine inlet temperatures by 200°F without an increase in the combustion temperature. Steam is also a much more effective heat transfer medium than air.

2. Increasing the efficiencies of turbomachinery components

The performance of early turbines suffered greatly from the inefficiencies of turbines and compressors. However, the advent of computers and advanced techniques for computer-aided design made it possible to design these components aerodynamically with minimal losses. The increased efficiencies of the turbines and compressors resulted in a significant increase in the cycle efficiency.

3. Adding modifications to the basic cycle

The simple-cycle efficiencies of early gas turbines were practically doubled by incorporating intercooling, regeneration (or recuperation), and reheating, discussed in the next two sections. These improvements, of course, come at the expense of increased initial and operation costs, and they cannot be justified unless the decrease in fuel costs offsets the increase in other costs. The relatively low fuel prices, the general desire in the industry to minimize installation costs, and the tremendous increase in the simple-cycle efficiency to about 40 percent left little desire for opting for these modifications.

The first gas turbine for an electric utility was installed in 1949 in Oklahoma as part of a combined-cycle power plant. It was built by General Electric and produced 3.5 MW of power. Gas turbines installed until the mid-1970s suffered from low efficiency and poor reliability. In the past, the base-load electric power generation was dominated by large coal and nuclear power plants. However, there has been an historic shift toward natural gas-fired gas turbines because of their higher efficiencies, lower capital costs, shorter installation times, and better emission characteristics, and the abundance of natural gas supplies, and more and more electric utilities are using gas turbines for base-load power production as well as for peaking. The construction costs for gas-turbine power plants are roughly half that of comparable conventional fossil-fuel steam power plants, which were the primary base-load power plants until the early 1980s. More than half of all power plants to be installed in the foreseeable future are forecast to be gas-turbine or combined gas-steam turbine types.

A gas turbine manufactured by General Electric in the early 1990s had a pressure ratio of 13.5 and generated 135.7 MW of net power at a thermal efficiency of 33 percent in simple-cycle operation. A more recent gas turbine manufactured by General Electric uses a turbine inlet temperature of 1425°C (2600°F) and produces up to 282 MW while achieving a thermal efficiency of 39.5 percent in the simple-cycle mode. A 1.3-ton small-scale gas turbine labeled OP-16, built by the Dutch firm Opra Optimal Radial Turbine, can run on gas or liquid fuel and can replace a 16-ton diesel engine. It has a pressure ratio of 6.5 and produces up to 2 MW of power. Its efficiency is 26 percent in the simple-cycle operation, which rises to 37 percent when equipped with a regenerator.

22 | Fundamentals of Thermal-Fluid Sciences

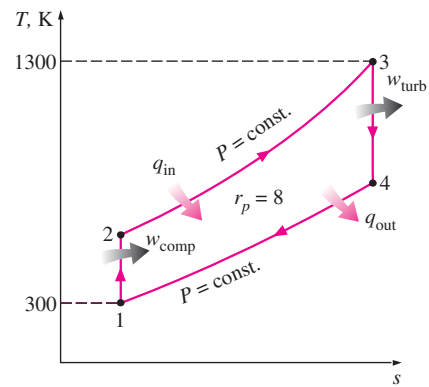

FIGURE 31

T - s diagram for the Brayton cycle discussed in Example 4.

EXAMPLE 4 The Simple Ideal Brayton Cycle

A gas-turbine power plant operating on an ideal Brayton cycle has a pressure ratio of 8. The gas temperature is 300 K at the compressor inlet and 1300 K at the turbine inlet. Utilizing the air-standard assumptions, determine (a) the gas temperature at the exits of the compressor and the turbine, (b) the back work ratio, and (c) the thermal efficiency.

Solution A power plant operating on the ideal Brayton cycle is considered. The compressor and turbine exit temperatures, back work ratio, and the thermal efficiency are to be determined.

Assumptions 1 Steady operating conditions exist. 2 The air-standard assumptions are applicable. 3 Kinetic and potential energy changes are negligible. 4 The variation of specific heats with temperature is to be considered.

Analysis The T - s diagram of the ideal Brayton cycle described is shown in Fig. 31. We note that the components involved in the Brayton cycle are steady-flow devices.

(a) The air temperatures at the compressor and turbine exits are determined from isentropic relations:

Process 1-2 (isentropic compression of an ideal gas):

$$T_1 = 300 \text{ K} \rightarrow h_1 = 300.19 \text{ kJ/kg}$$

$$P_{r1} = 1.386$$

$$P_{r2} = \frac{P_2}{P_1} P_{r1} = (8)(1.386) = 11.09 \rightarrow T_2 = \mathbf{540 \text{ K}} \quad (\text{at compressor exit})$$

$$h_2 = 544.35 \text{ kJ/kg}$$

Process 3-4 (isentropic expansion of an ideal gas):

$$T_3 = 1300 \text{ K} \rightarrow h_3 = 1395.97 \text{ kJ/kg}$$

$$P_{r3} = 330.9$$

$$P_{r4} = \frac{P_4}{P_3} P_{r3} = \left(\frac{1}{8}\right)(330.9) = 41.36 \rightarrow T_4 = \mathbf{770 \text{ K}} \quad (\text{at turbine exit})$$

$$h_4 = 789.37 \text{ kJ/kg}$$

(b) To find the back work ratio, we need to find the work input to the compressor and the work output of the turbine:

$$w_{\text{comp,in}} = h_2 - h_1 = 544.35 - 300.19 = 244.16 \text{ kJ/kg}$$

$$w_{\text{turb,out}} = h_3 - h_4 = 1395.97 - 789.37 = 606.60 \text{ kJ/kg}$$

Thus,

$$r_{\text{bw}} = \frac{w_{\text{comp,in}}}{w_{\text{turb,out}}} = \frac{244.16 \text{ kJ/kg}}{606.60 \text{ kJ/kg}} = \mathbf{0.403}$$

That is, 40.3 percent of the turbine work output is used just to drive the compressor.

(c) The thermal efficiency of the cycle is the ratio of the net power output to the total heat input:

$$q_{\text{in}} = h_3 - h_2 = 1395.97 - 544.35 = 851.62 \text{ kJ/kg}$$

$$w_{\text{net}} = w_{\text{out}} - w_{\text{in}} = 606.60 - 244.16 = 362.4 \text{ kJ/kg}$$

Thus,

$$\eta_{\text{th}} = \frac{w_{\text{net}}}{q_{\text{in}}} = \frac{362.4 \text{ kJ/kg}}{851.62 \text{ kJ/kg}} = \mathbf{0.426 \text{ or } 42.6\%}$$

The thermal efficiency could also be determined from

$$\eta_{\text{th}} = 1 - \frac{q_{\text{out}}}{q_{\text{in}}}$$

where

$$q_{\text{out}} = h_4 - h_1 = 789.37 - 300.19 = 489.2 \text{ kJ/kg}$$

Discussion Under the cold-air-standard assumptions (constant specific heat values at room temperature), the thermal efficiency would be, from Eq. 16,

$$\eta_{\text{th,Brayton}} = 1 - \frac{1}{r_p^{(k-1)/k}} = 1 - \frac{1}{8^{(1.4-1)/1.4}} = 0.448$$

which is sufficiently close to the value obtained by accounting for the variation of specific heats with temperature.

Deviation of Actual Gas-Turbine Cycles from Idealized Ones

The actual gas-turbine cycle differs from the ideal Brayton cycle on several accounts. For one thing, some pressure drop during the heat-addition and heat-rejection processes is inevitable. More importantly, the actual work input to the compressor is more, and the actual work output from the turbine is less because of irreversibilities. The deviation of actual compressor and turbine behavior from the idealized isentropic behavior can be accurately accounted for by utilizing the isentropic efficiencies of the turbine and compressor as

$$\eta_C = \frac{w_s}{w_a} \cong \frac{h_{2s} - h_1}{h_{2a} - h_1} \quad (18)$$

and

$$\eta_T = \frac{w_a}{w_s} \cong \frac{h_3 - h_{4a}}{h_3 - h_{4s}} \quad (19)$$

where states $2a$ and $4a$ are the actual exit states of the compressor and the turbine, respectively, and $2s$ and $4s$ are the corresponding states for the isentropic case, as illustrated in Fig. 32. The effect of the turbine and compressor efficiencies on the thermal efficiency of the gas-turbine engines is illustrated below with an example.

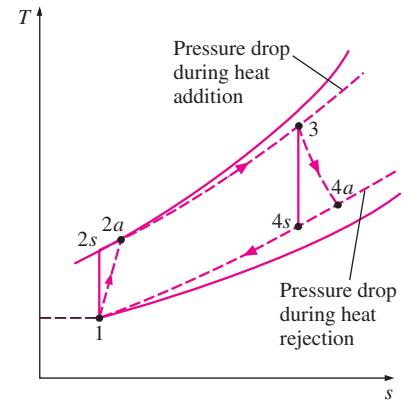

FIGURE 32

The deviation of an actual gas-turbine cycle from the ideal Brayton cycle as a result of irreversibilities.

24 | Fundamentals of Thermal-Fluid Sciences

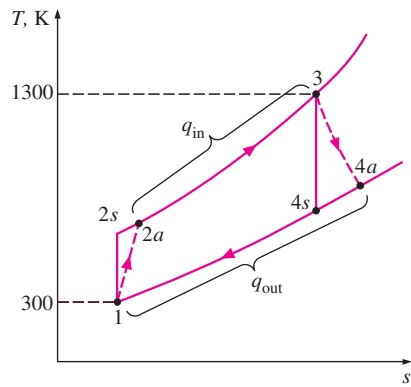

FIGURE 33

T - s diagram of the gas-turbine cycle discussed in Example 5.

EXAMPLE 5 An Actual Gas-Turbine Cycle

Assuming a compressor efficiency of 80 percent and a turbine efficiency of 85 percent, determine (a) the back work ratio, (b) the thermal efficiency, and (c) the turbine exit temperature of the gas-turbine cycle discussed in Example 4.

Solution The Brayton cycle discussed in Example 4 is reconsidered. For specified turbine and compressor efficiencies, the back work ratio, the thermal efficiency, and the turbine exit temperature are to be determined.

Analysis (a) The T - s diagram of the cycle is shown in Fig. 33. The actual compressor work and turbine work are determined by using the definitions of compressor and turbine efficiencies, Eqs. 18 and 19:

$$\text{Compressor: } w_{\text{comp,in}} = \frac{w_s}{\eta_C} = \frac{244.16 \text{ kJ/kg}}{0.80} = 305.20 \text{ kJ/kg}$$

$$\text{Turbine: } w_{\text{turb,out}} = \eta_T w_s = (0.85)(606.60 \text{ kJ/kg}) = 515.61 \text{ kJ/kg}$$

Thus,

$$r_{\text{bw}} = \frac{w_{\text{comp,in}}}{w_{\text{turb,out}}} = \frac{305.20 \text{ kJ/kg}}{515.61 \text{ kJ/kg}} = \mathbf{0.592}$$

That is, the compressor is now consuming 59.2 percent of the work produced by the turbine (up from 40.3 percent). This increase is due to the irreversibilities that occur within the compressor and the turbine.

(b) In this case, air leaves the compressor at a higher temperature and enthalpy, which are determined to be

$$\begin{aligned} w_{\text{comp,in}} &= h_{2a} - h_1 \rightarrow h_{2a} = h_1 + w_{\text{comp,in}} \\ &= 300.19 + 305.20 \\ &= 605.39 \text{ kJ/kg} \quad (\text{and } T_{2a} = 598 \text{ K}) \end{aligned}$$

Thus,

$$q_{\text{in}} = h_3 - h_{2a} = 1395.97 - 605.39 = 790.58 \text{ kJ/kg}$$

$$w_{\text{net}} = w_{\text{out}} - w_{\text{in}} = 515.61 - 305.20 = 210.41 \text{ kJ/kg}$$

and

$$\eta_{\text{th}} = \frac{w_{\text{net}}}{q_{\text{in}}} = \frac{210.41 \text{ kJ/kg}}{790.58 \text{ kJ/kg}} = \mathbf{0.266 \text{ or } 26.6\%}$$

That is, the irreversibilities occurring within the turbine and compressor caused the thermal efficiency of the gas turbine cycle to drop from 42.6 to 26.6 percent. This example shows how sensitive the performance of a gas-turbine power plant is to the efficiencies of the compressor and the turbine. In fact, gas-turbine efficiencies did not reach competitive values until significant improvements were made in the design of gas turbines and compressors.

(c) The air temperature at the turbine exit is determined from an energy balance on the turbine:

$$\begin{aligned} w_{\text{turb,out}} &= h_3 - h_{4a} \rightarrow h_{4a} = h_3 - w_{\text{turb,out}} \\ &= 1395.97 - 515.61 \\ &= 880.36 \text{ kJ/kg} \end{aligned}$$

Then, from Table A-17,

$$T_{4a} = 853 \text{ K}$$

Discussion The temperature at turbine exit is considerably higher than that at the compressor exit ($T_{2a} = 598 \text{ K}$), which suggests the use of regeneration to reduce fuel cost.

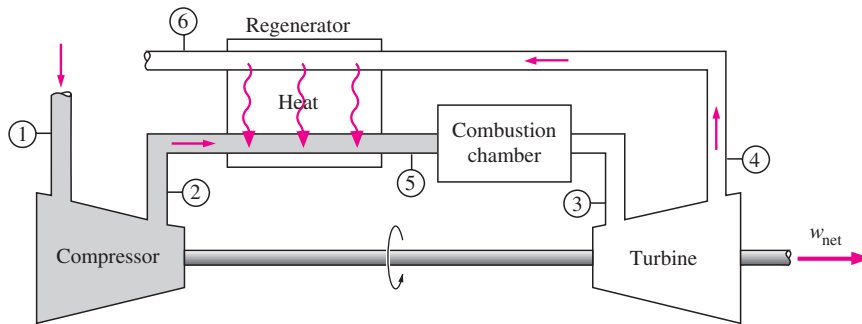

FIGURE 34

A gas-turbine engine with regenerator.

8 ■ THE BRAYTON CYCLE WITH REGENERATION

In gas-turbine engines, the temperature of the exhaust gas leaving the turbine is often considerably higher than the temperature of the air leaving the compressor. Therefore, the high-pressure air leaving the compressor can be heated by transferring heat to it from the hot exhaust gases in a counter-flow heat exchanger, which is also known as a *regenerator* or a *recuperator*. A sketch of the gas-turbine engine utilizing a regenerator and the T - s diagram of the new cycle are shown in Figs. 34 and 35, respectively.

The thermal efficiency of the Brayton cycle increases as a result of regeneration since the portion of energy of the exhaust gases that is normally rejected to the surroundings is now used to preheat the air entering the combustion chamber. This, in turn, decreases the heat input (thus fuel) requirements for the same net work output. Note, however, that the use of a regenerator is recommended only when the turbine exhaust temperature is higher than the compressor exit temperature. Otherwise, heat will flow in the reverse direction (to the exhaust gases), decreasing the efficiency. This situation is encountered in gas-turbine engines operating at very high pressure ratios.

The highest temperature occurring within the regenerator is T_4 , the temperature of the exhaust gases leaving the turbine and entering the regenerator. Under no conditions can the air be preheated in the regenerator to a temperature above this value. Air normally leaves the regenerator at a lower temperature, T_5 . In the limiting (ideal) case, the air exits the regenerator at the inlet temperature of the exhaust gases T_4 . Assuming the regenerator to be well insulated and any changes in kinetic and potential energies to be negligible, the actual and maximum heat transfers from the exhaust gases to the air can be expressed as

$$q_{\text{regen,act}} = h_5 - h_2 \quad (20)$$

and

$$q_{\text{regen,max}} = h_{5'} - h_2 = h_4 - h_2 \quad (21)$$

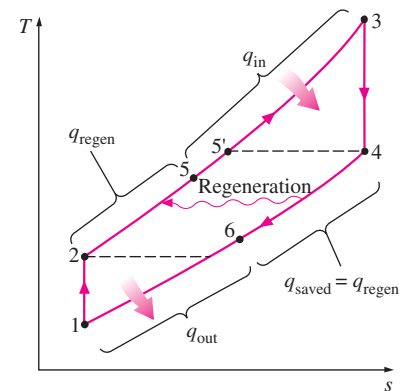

FIGURE 35

T - s diagram of a Brayton cycle with regeneration.

26 | Fundamentals of Thermal-Fluid Sciences

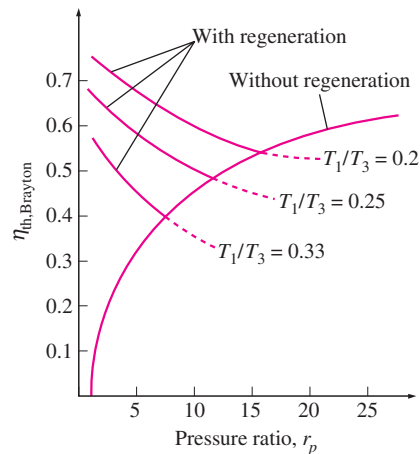

FIGURE 36

Thermal efficiency of the ideal Brayton cycle with and without regeneration.

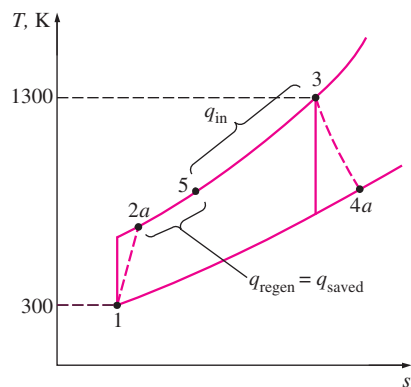

FIGURE 37

T - s diagram of the regenerative Brayton cycle described in Example 6.

The extent to which a regenerator approaches an ideal regenerator is called the **effectiveness** ϵ and is defined as

$$\epsilon = \frac{q_{\text{regen,act}}}{q_{\text{regen,max}}} = \frac{h_5 - h_2}{h_4 - h_2} \quad (22)$$

When the cold-air-standard assumptions are utilized, it reduces to

$$\epsilon \cong \frac{T_5 - T_2}{T_4 - T_2} \quad (23)$$

A regenerator with a higher effectiveness obviously saves a greater amount of fuel since it preheats the air to a higher temperature prior to combustion. However, achieving a higher effectiveness requires the use of a larger regenerator, which carries a higher price tag and causes a larger pressure drop. Therefore, the use of a regenerator with a very high effectiveness cannot be justified economically unless the savings from the fuel costs exceed the additional expenses involved. The effectiveness of most regenerators used in practice is below 0.85.

Under the cold-air-standard assumptions, the thermal efficiency of an ideal Brayton cycle with regeneration is

$$\eta_{\text{th,regen}} = 1 - \left(\frac{T_1}{T_3} \right) (r_p)^{(k-1)/k} \quad (24)$$

Therefore, the thermal efficiency of an ideal Brayton cycle with regeneration depends on the ratio of the minimum to maximum temperatures as well as the pressure ratio. The thermal efficiency is plotted in Fig. 36 for various pressure ratios and minimum-to-maximum temperature ratios. This figure shows that regeneration is most effective at lower pressure ratios and low minimum-to-maximum temperature ratios.

EXAMPLE 6 Actual Gas-Turbine Cycle with Regeneration

Determine the thermal efficiency of the gas-turbine described in Example 5 if a regenerator having an effectiveness of 80 percent is installed.

Solution The gas-turbine discussed in Example 5 is equipped with a regenerator. For a specified effectiveness, the thermal efficiency is to be determined.

Analysis The T - s diagram of the cycle is shown in Fig. 37. We first determine the enthalpy of the air at the exit of the regenerator, using the definition of effectiveness:

$$\begin{aligned} \epsilon &= \frac{h_5 - h_{2a}}{h_{4a} - h_{2a}} \\ 0.80 &= \frac{(h_5 - 605.39) \text{ kJ/kg}}{(880.36 - 605.39) \text{ kJ/kg}} \rightarrow h_5 = 825.37 \text{ kJ/kg} \end{aligned}$$

Thus,

$$q_{\text{in}} = h_3 - h_5 = (1395.97 - 825.37) \text{ kJ/kg} = 570.60 \text{ kJ/kg}$$

This represents a savings of 220.0 kJ/kg from the heat input requirements. The addition of a regenerator (assumed to be frictionless) does not affect the net work output. Thus,

$$\eta_{\text{th}} = \frac{w_{\text{net}}}{q_{\text{in}}} = \frac{210.41 \text{ kJ/kg}}{570.60 \text{ kJ/kg}} = \mathbf{0.369 \text{ or } 36.9\%}$$

Discussion Note that the thermal efficiency of the gas turbine has gone up from 26.6 to 36.9 percent as a result of installing a regenerator that helps to recuperate some of the thermal energy of the exhaust gases.

9 ■ THE CARNOT VAPOR CYCLE

We have mentioned repeatedly that the Carnot cycle is the most efficient cycle operating between two specified temperature limits. Thus it is natural to look at the Carnot cycle first as a prospective ideal cycle for vapor power plants. If we could, we would certainly adopt it as the ideal cycle. As explained below, however, the Carnot cycle is not a suitable model for power cycles. Throughout the discussions, we assume *steam* to be the working fluid since it is the working fluid predominantly used in vapor power cycles.

Consider a steady-flow *Carnot cycle* executed within the saturation dome of a pure substance, as shown in Fig. 9-38a. The fluid is heated reversibly and isothermally in a boiler (process 1-2), expanded isentropically in a turbine (process 2-3), condensed reversibly and isothermally in a condenser (process 3-4), and compressed isentropically by a compressor to the initial state (process 4-1).

Several impracticalities are associated with this cycle:

1. Isothermal heat transfer to or from a two-phase system is not difficult to achieve in practice since maintaining a constant pressure in the device automatically fixes the temperature at the saturation value. Therefore, processes 1-2 and 3-4 can be approached closely in actual boilers and condensers. Limiting the heat transfer processes to two-phase systems, however, severely limits the maximum temperature that can be used in the cycle (it has to remain under the critical-point value, which is 374°C for water). Limiting the maximum temperature in the cycle also limits the thermal efficiency. Any attempt to raise the maximum temperature in the cycle involves heat transfer to the working fluid in a single phase, which is not easy to accomplish isothermally.

2. The isentropic expansion process (process 2-3) can be approximated closely by a well-designed expansion turbine. However, the quality of the steam decreases during this process, as shown on the T - s diagram in Fig. 38a. Thus the turbine has to handle steam with low quality, that is, steam with a high moisture content. The impingement of liquid droplets on the turbine blades causes erosion and is a major source of wear. Thus steam with qualities less than about 90 percent cannot be tolerated in the operation of power plants. This problem could be eliminated by using a working fluid with a very steep saturated vapor line.

3. The isentropic compression process (process 4-1) involves the compression of a liquid-vapor mixture to a saturated liquid. There are two

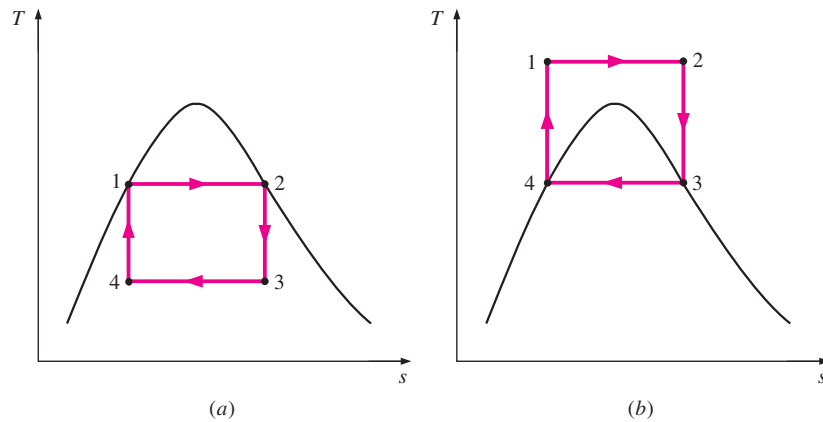
**FIGURE 38**

T-s diagram of two Carnot vapor cycles.

difficulties associated with this process. First, it is not easy to control the condensation process so precisely as to end up with the desired quality at state 4. Second, it is not practical to design a compressor that handles two phases.

Some of these problems could be eliminated by executing the Carnot cycle in a different way, as shown in Fig. 38*b*. This cycle, however, presents other problems such as isentropic compression to extremely high pressures and isothermal heat transfer at variable pressures. Thus we conclude that the Carnot cycle cannot be approximated in actual devices and is not a realistic model for vapor power cycles.

10 ■ RANKINE CYCLE: THE IDEAL CYCLE FOR VAPOR POWER CYCLES

Many of the impracticalities associated with the Carnot cycle can be eliminated by superheating the steam in the boiler and condensing it completely in the condenser, as shown schematically on a *T-s* diagram in Fig. 39. The cycle that results is the **Rankine cycle**, which is the ideal cycle for vapor power plants. The ideal Rankine cycle does not involve any internal irreversibilities and consists of the following four processes:

- 1-2 Isentropic compression in a pump
- 2-3 Constant pressure heat addition in a boiler
- 3-4 Isentropic expansion in a turbine
- 4-1 Constant pressure heat rejection in a condenser

Water enters the *pump* at state 1 as saturated liquid and is compressed isentropically to the operating pressure of the boiler. The water temperature increases somewhat during this isentropic compression process due to a slight decrease in the specific volume of water. The vertical distance between states 1 and 2 on the *T-s* diagram is greatly exaggerated for clarity. (If water were truly incompressible, would there be a temperature change at all during this process?)

Water enters the *boiler* as a compressed liquid at state 2 and leaves as a superheated vapor at state 3. The boiler is basically a large heat exchanger where the heat originating from combustion gases, nuclear reactors, or other

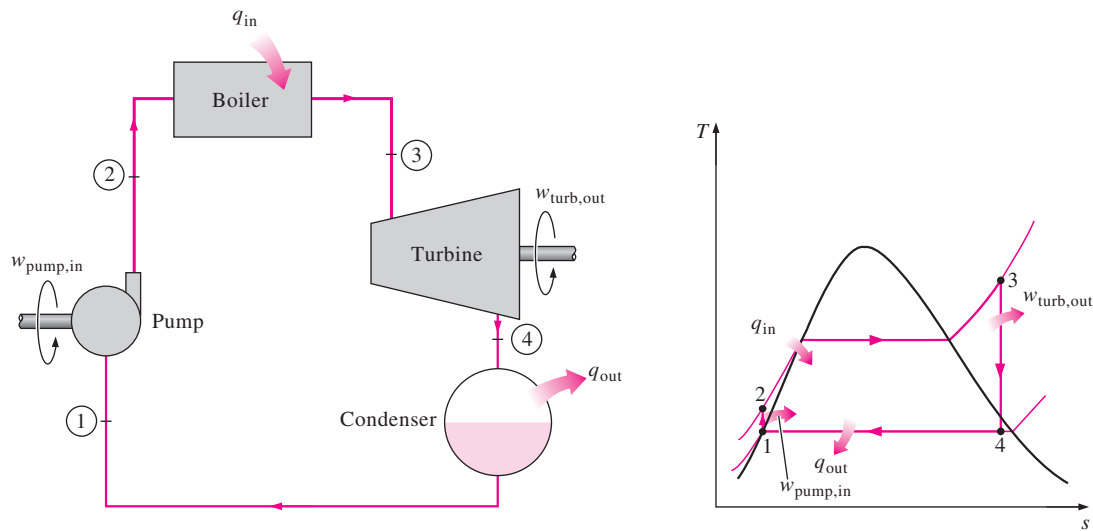

FIGURE 39
The simple ideal Rankine cycle.

sources is transferred to the water essentially at constant pressure. The boiler, together with the section where the steam is superheated (the superheater), is often called the *steam generator*.

The superheated vapor at state 3 enters the *turbine*, where it expands isentropically and produces work by rotating the shaft connected to an electric generator. The pressure and the temperature of steam drop during this process to the values at state 4, where steam enters the *condenser*. At this state, steam is usually a saturated liquid–vapor mixture with a high quality. Steam is condensed at constant pressure in the condenser, which is basically a large heat exchanger, by rejecting heat to a cooling medium such as a lake, a river, or the atmosphere. Steam leaves the condenser as saturated liquid and enters the pump, completing the cycle. In areas where water is precious, the power plants are cooled by air instead of water. This method of cooling, which is also used in car engines, is called *dry cooling*. Several power plants in the world, including some in the United States, use dry cooling to conserve water.

Remembering that the area under the process curve on a T - s diagram represents the heat transfer for internally reversible processes, we see that the area under process curve 2-3 represents the heat transferred to the water in the boiler and the area under the process curve 4-1 represents the heat rejected in the condenser. The difference between these two (the area enclosed by the cycle curve) is the net work produced during the cycle.

Energy Analysis of the Ideal Rankine Cycle

All four components associated with the Rankine cycle (the pump, boiler, turbine, and condenser) are steady-flow devices, and thus all four processes that make up the Rankine cycle can be analyzed as steady-flow processes. The

30 | Fundamentals of Thermal-Fluid Sciences

kinetic and potential energy changes of the steam are usually small relative to the work and heat transfer terms and are therefore usually neglected. Then the *steady-flow energy equation* per unit mass of steam reduces to

$$(q_{\text{in}} - q_{\text{out}}) + (w_{\text{in}} - w_{\text{out}}) = h_e - h_i \quad (\text{kJ/kg}) \quad (25)$$

The boiler and the condenser do not involve any work, and the pump and the turbine are assumed to be isentropic. Then the conservation of energy relation for each device can be expressed as follows:

$$\text{Pump } (q = 0): \quad w_{\text{pump,in}} = h_2 - h_1 \quad (26)$$

or,

$$w_{\text{pump,in}} = v(P_2 - P_1) \quad (27)$$

where

$$h_1 = h_{f @ P_1} \quad \text{and} \quad v \cong v_1 = v_{f @ P_1} \quad (28)$$

$$\text{Boiler } (w = 0): \quad q_{\text{in}} = h_3 - h_2 \quad (29)$$

$$\text{Turbine } (q = 0): \quad w_{\text{turb,out}} = h_3 - h_4 \quad (30)$$

$$\text{Condenser } (w = 0): \quad q_{\text{out}} = h_4 - h_1 \quad (31)$$

The *thermal efficiency* of the Rankine cycle is determined from

$$\eta_{\text{th}} = \frac{w_{\text{net}}}{q_{\text{in}}} = 1 - \frac{q_{\text{out}}}{q_{\text{in}}} \quad (32)$$

where

$$w_{\text{net}} = q_{\text{in}} - q_{\text{out}} = w_{\text{turb,out}} - w_{\text{pump,in}}$$

The conversion efficiency of power plants in the United States is often expressed in terms of **heat rate**, which is the amount of heat supplied, in Btu's, to generate 1 kWh of electricity. The smaller the heat rate, the greater the efficiency. Considering that 1 kWh = 3412 Btu and disregarding the losses associated with the conversion of shaft power to electric power, the relation between the heat rate and the thermal efficiency can be expressed as

$$\eta_{\text{th}} = \frac{3412 \text{ (Btu/kWh)}}{\text{Heat rate (Btu/kWh)}} \quad (33)$$

For example, a heat rate of 11,363 Btu/kWh is equivalent to 30 percent efficiency.

The thermal efficiency can also be interpreted as the ratio of the area enclosed by the cycle on a T - s diagram to the area under the heat-addition process. The use of these relations is illustrated in the following example.

EXAMPLE 7 The Simple Ideal Rankine Cycle

Consider a steam power plant operating on the simple ideal Rankine cycle. Steam enters the turbine at 3 MPa and 350°C and is condensed in the condenser at a pressure of 75 kPa. Determine the thermal efficiency of this cycle.

Solution A steam power plant operating on the simple ideal Rankine cycle is considered. The thermal efficiency of the cycle is to be determined.

Assumptions 1 Steady operating conditions exist. 2 Kinetic and potential energy changes are negligible.

Analysis The schematic of the power plant and the T - s diagram of the cycle are shown in Fig. 40. We note that the power plant operates on the ideal Rankine cycle. Therefore, the pump and the turbine are isentropic, there are no pressure drops in the boiler and condenser, and steam leaves the condenser and enters the pump as saturated liquid at the condenser pressure.

First we determine the enthalpies at various points in the cycle, using data from steam tables (Tables A-4, A-5, and A-6):

$$\text{State 1: } \left. \begin{array}{l} P_1 = 75 \text{ kPa} \\ \text{Sat. liquid} \end{array} \right\} \begin{array}{l} h_1 = h_f @ 75 \text{ kPa} = 384.44 \text{ kJ/kg} \\ v_1 = v_f @ 75 \text{ kPa} = 0.001037 \text{ m}^3/\text{kg} \end{array}$$

$$\text{State 2: } P_2 = 3 \text{ MPa}$$

$$s_2 = s_1$$

$$w_{\text{pump,in}} = v_1(P_2 - P_1) = (0.001037 \text{ m}^3/\text{kg})[(3000 - 75) \text{ kPa}] \left(\frac{1 \text{ kJ}}{1 \text{ kPa} \cdot \text{m}^3} \right)$$

$$= 3.03 \text{ kJ/kg}$$

$$h_2 = h_1 + w_{\text{pump,in}} = (384.44 + 3.03) \text{ kJ/kg} = 387.47 \text{ kJ/kg}$$

$$\text{State 3: } \left. \begin{array}{l} P_3 = 3 \text{ MPa} \\ T_3 = 350^\circ\text{C} \end{array} \right\} \begin{array}{l} h_3 = 3116.1 \text{ kJ/kg} \\ s_3 = 6.7450 \text{ kJ/kg} \cdot \text{K} \end{array}$$

$$\text{State 4: } P_4 = 75 \text{ kPa} \quad (\text{sat. mixture})$$

$$s_4 = s_3$$

$$x_4 = \frac{s_4 - s_f}{s_{fg}} = \frac{6.7450 - 1.2132}{6.2426} = 0.8861$$

$$h_4 = h_f + x_4 h_{fg} = 384.44 + 0.8861(2278.0) = 2403.0 \text{ kJ/kg}$$

Thus,

$$q_{\text{in}} = h_3 - h_2 = (3116.1 - 387.47) \text{ kJ/kg} = 2728.6 \text{ kJ/kg}$$

$$q_{\text{out}} = h_4 - h_1 = (2403.0 - 384.44) \text{ kJ/kg} = 2018.6 \text{ kJ/kg}$$

and

$$\eta_{\text{th}} = 1 - \frac{q_{\text{out}}}{q_{\text{in}}} = 1 - \frac{2018.6 \text{ kJ/kg}}{2728.6 \text{ kJ/kg}} = \mathbf{0.260 \text{ or } 26.0\%}$$

The thermal efficiency could also be determined from

$$w_{\text{turb,out}} = h_3 - h_4 = (3116.1 - 2403.0) \text{ kJ/kg} = 713.1 \text{ kJ/kg}$$

$$w_{\text{net}} = w_{\text{turb,out}} - w_{\text{pump,in}} = (713.1 - 3.03) \text{ kJ/kg} = 710.1 \text{ kJ/kg}$$

or

$$w_{\text{net}} = q_{\text{in}} - q_{\text{out}} = (2728.6 - 2018.6) \text{ kJ/kg} = 710.0 \text{ kJ/kg}$$

and

$$\eta_{\text{th}} = \frac{w_{\text{net}}}{q_{\text{in}}} = \frac{710.0 \text{ kJ/kg}}{2728.6 \text{ kJ/kg}} = \mathbf{0.260 \text{ or } 26.0\%}$$

32 | Fundamentals of Thermal-Fluid Sciences

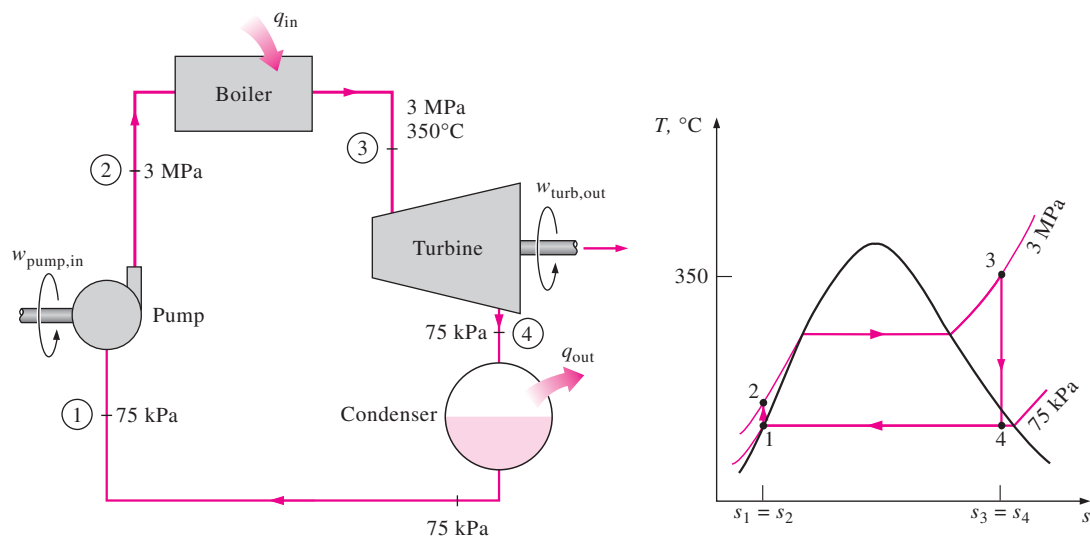

FIGURE 40
Schematic and T - s diagram for Example 7.

That is, this power plant converts 26 percent of the heat it receives in the boiler to net work. An actual power plant operating between the same temperature and pressure limits will have a lower efficiency because of the irreversibilities such as friction.

Discussion Notice that the back work ratio ($r_{bw} = w_{in}/w_{out}$) of this power plant is 0.004, and thus only 0.4 percent of the turbine work output is required to operate the pump. Having such low back work ratios is characteristic of vapor power cycles. This is in contrast to the gas power cycles, which typically involve very high back work ratios (about 40 to 80 percent).

It is also interesting to note the thermal efficiency of a Carnot cycle operating between the same temperature limits

$$\eta_{th,Carnot} = 1 - \frac{T_{min}}{T_{max}} = 1 - \frac{(91.76 + 273) \text{ K}}{(350 + 273) \text{ K}} = 0.415$$

The difference between the two efficiencies is due to the large external irreversibility in Rankine cycle caused by the large temperature difference between steam and combustion gases in the furnace.

11 ■ DEVIATION OF ACTUAL VAPOR POWER CYCLES FROM IDEALIZED ONES

The actual vapor power cycle differs from the ideal Rankine cycle, as illustrated in Fig. 41a, as a result of irreversibilities in various components. Fluid friction and heat loss to the surroundings are the two common sources of irreversibilities.

Fluid friction causes pressure drops in the boiler, the condenser, and the piping between various components. As a result, steam leaves the boiler at a somewhat lower pressure. Also, the pressure at the turbine inlet is somewhat lower than that at the boiler exit due to the pressure drop in the connecting pipes. The pressure drop in the condenser is usually very small. To compen-

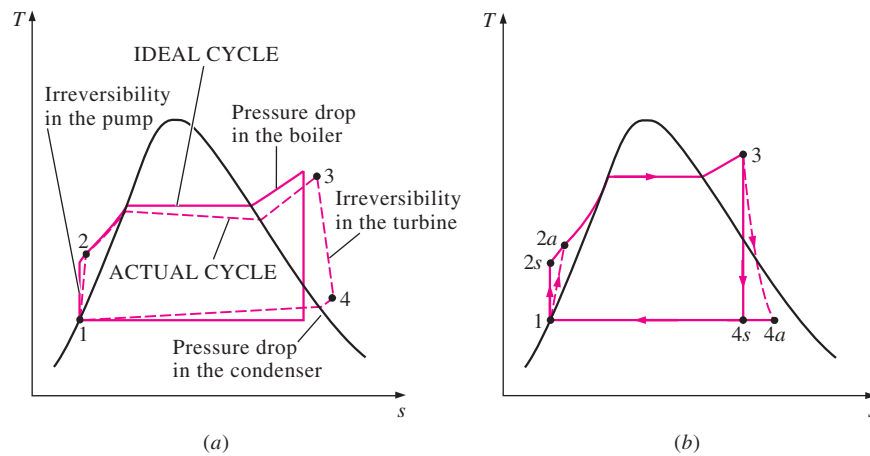
**FIGURE 41**

(a) Deviation of actual vapor power cycle from the ideal Rankine cycle. (b) The effect of pump and turbine irreversibilities on the ideal Rankine cycle.

sate for these pressure drops, the water must be pumped to a sufficiently higher pressure than the ideal cycle calls for. This requires a larger pump and larger work input to the pump.

The other major source of irreversibility is the *heat loss* from the steam to the surroundings as the steam flows through various components. To maintain the same level of net work output, more heat needs to be transferred to the steam in the boiler to compensate for these undesired heat losses. As a result, cycle efficiency decreases.

Of particular importance are the irreversibilities occurring within the pump and the turbine. A pump requires a greater work input, and a turbine produces a smaller work output as a result of irreversibilities. Under ideal conditions, the flow through these devices is isentropic. The deviation of actual pumps and turbines from the isentropic ones can be accounted for by utilizing *isentropic efficiencies*, defined as

$$\eta_P = \frac{w_s}{w_a} = \frac{h_{2s} - h_1}{h_{2a} - h_1} \quad (34)$$

and

$$\eta_T = \frac{w_a}{w_s} = \frac{h_3 - h_{4a}}{h_3 - h_{4s}} \quad (35)$$

where states 2a and 4a are the actual exit states of the pump and the turbine, respectively, and 2s and 4s are the corresponding states for the isentropic case (Fig. 41b).

Other factors also need to be considered in the analysis of actual vapor power cycles. In actual condensers, for example, the liquid is usually sub-cooled to prevent the onset of *cavitation*, the rapid vaporization and condensation of the fluid at the low-pressure side of the pump impeller, which may damage it. Additional losses occur at the bearings between the moving parts as a result of friction. Steam that leaks out during the cycle and air that leaks into the condenser represent two other sources of loss. Finally, the power consumed by the auxiliary equipment such as fans that supply air to

34 | Fundamentals of Thermal-Fluid Sciences

the furnace should also be considered in evaluating the overall performance of power plants.

The effect of irreversibilities on the thermal efficiency of a steam power cycle is illustrated below with an example.

EXAMPLE 8 An Actual Steam Power Cycle

A steam power plant operates on the cycle shown in Fig. 42. If the isentropic efficiency of the turbine is 87 percent and the isentropic efficiency of the pump is 85 percent, determine (a) the thermal efficiency of the cycle and (b) the net power output of the plant for a mass flow rate of 15 kg/s.

Solution A steam power cycle with specified turbine and pump efficiencies is considered. The thermal efficiency and the net power output are to be determined.

Assumptions 1 Steady operating conditions exist. 2 Kinetic and potential energy changes are negligible.

Analysis The schematic of the power plant and the T - s diagram of the cycle are shown in Fig. 42. The temperatures and pressures of steam at various points are also indicated on the figure. We note that the power plant involves steady-flow components and operates on the Rankine cycle, but the imperfections at various components are accounted for.

(a) The thermal efficiency of a cycle is the ratio of the net work output to the heat input, and it is determined as follows:

Pump work input:

$$\begin{aligned} w_{\text{pump,in}} &= \frac{w_{s,\text{pump,in}}}{\eta_p} = \frac{v_1(P_2 - P_1)}{\eta_p} \\ &= \frac{(0.001009 \text{ m}^3/\text{kg})[(16,000 - 9) \text{ kPa}]}{0.85} \left(\frac{1 \text{ kJ}}{1 \text{ kPa} \cdot \text{m}^3} \right) \\ &= 19.0 \text{ kJ/kg} \end{aligned}$$

Turbine work output:

$$\begin{aligned} w_{\text{turb,out}} &= \eta_T w_{s,\text{turb,out}} \\ &= \eta_T (h_5 - h_{6s}) = 0.87(3583.1 - 2115.3) \text{ kJ/kg} \\ &= 1277.0 \text{ kJ/kg} \end{aligned}$$

$$\text{Boiler heat input: } q_{\text{in}} = h_4 - h_3 = (3647.6 - 160.1) \text{ kJ/kg} = 3487.5 \text{ kJ/kg}$$

Thus,

$$w_{\text{net}} = w_{\text{turb,out}} - w_{\text{pump,in}} = (1277.0 - 19.0) \text{ kJ/kg} = 1258.0 \text{ kJ/kg}$$

$$\eta_{\text{th}} = \frac{w_{\text{net}}}{q_{\text{in}}} = \frac{1258.0 \text{ kJ/kg}}{3487.5 \text{ kJ/kg}} = \mathbf{0.361 \text{ or } 36.1\%}$$

(b) The power produced by this power plant is

$$\dot{W}_{\text{net}} = \dot{m}(w_{\text{net}}) = (15 \text{ kg/s})(1258.0 \text{ kJ/kg}) = \mathbf{18.9 \text{ MW}}$$

Discussion Without the irreversibilities, the thermal efficiency of this cycle would be 43.0 percent (see Example 9c).

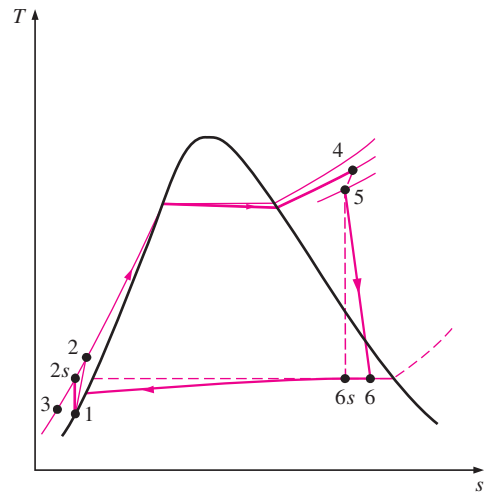
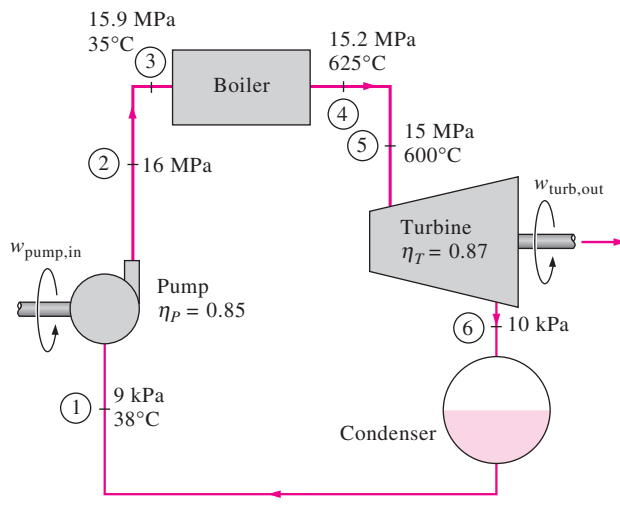

FIGURE 42
Schematic and T - s diagram for Example 8.

12 ■ HOW CAN WE INCREASE THE EFFICIENCY OF THE RANKINE CYCLE?

Steam power plants are responsible for the production of most electric power in the world, and even small increases in thermal efficiency can mean large savings from the fuel requirements. Therefore, every effort is made to improve the efficiency of the cycle on which steam power plants operate.

The basic idea behind all the modifications to increase the thermal efficiency of a power cycle is the same: *Increase the average temperature at which heat is transferred to the working fluid in the boiler, or decrease the average temperature at which heat is rejected from the working fluid in the condenser.* That is, the average fluid temperature should be as high as possible during heat addition and as low as possible during heat rejection. Next we discuss three ways of accomplishing this for the simple ideal Rankine cycle.

Lowering the Condenser Pressure (Lowers $T_{\text{low,avg}}$)

Steam exists as a saturated mixture in the condenser at the saturation temperature corresponding to the pressure inside the condenser. Therefore, lowering the operating pressure of the condenser automatically lowers the temperature of the steam, and thus the temperature at which heat is rejected.

The effect of lowering the condenser pressure on the Rankine cycle efficiency is illustrated on a T - s diagram in Fig. 43. For comparison purposes, the turbine inlet state is maintained the same. The colored area on this diagram represents the increase in net work output as a result of lowering the condenser pressure from P_4 to P'_4 . The heat input requirements also increase (represented by the area under curve $2'-2$), but this increase is very small. Thus the overall effect of lowering the condenser pressure is an increase in the thermal efficiency of the cycle.

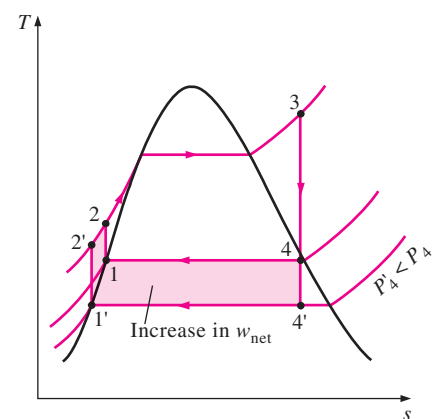

FIGURE 43
The effect of lowering the condenser pressure on the ideal Rankine cycle.

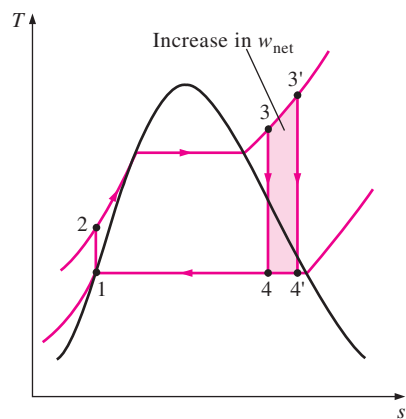

FIGURE 44

The effect of superheating the steam to higher temperatures on the ideal Rankine cycle.

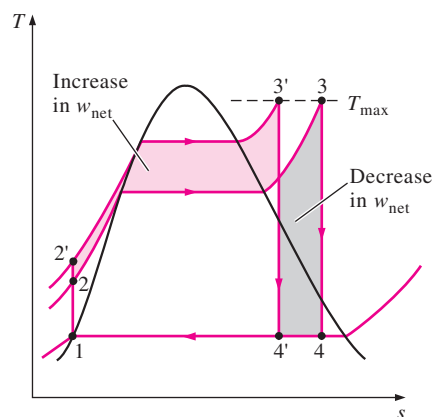

FIGURE 45

The effect of increasing the boiler pressure on the ideal Rankine cycle.

To take advantage of the increased efficiencies at low pressures, the condensers of steam power plants usually operate well below the atmospheric pressure. This does not present a major problem since the vapor power cycles operate in a closed loop. However, there is a lower limit on the condenser pressure that can be used. It cannot be lower than the saturation pressure corresponding to the temperature of the cooling medium. Consider, for example, a condenser that is to be cooled by a nearby river at 15°C . Allowing a temperature difference of 10°C for effective heat transfer, the steam temperature in the condenser must be above 25°C ; thus the condenser pressure must be above 3.2 kPa, which is the saturation pressure at 25°C .

Lowering the condenser pressure is not without any side effects, however. For one thing, it creates the possibility of air leakage into the condenser. More importantly, it increases the moisture content of the steam at the final stages of the turbine, as can be seen from Fig. 43. The presence of large quantities of moisture is highly undesirable in turbines because it decreases the turbine efficiency and erodes the turbine blades. Fortunately, this problem can be corrected, as discussed next.

Superheating the Steam to High Temperatures (Increases $T_{\text{high,avg}}$)

The average temperature at which heat is transferred to steam can be increased without increasing the boiler pressure by superheating the steam to high temperatures. The effect of superheating on the performance of vapor power cycles is illustrated on a T - s diagram in Fig. 44. The colored area on this diagram represents the increase in the net work. The total area under the process curve 3-3' represents the increase in the heat input. Thus both the net work and heat input increase as a result of superheating the steam to a higher temperature. The overall effect is an increase in thermal efficiency, however, since the average temperature at which heat is added increases.

Superheating the steam to higher temperatures has another very desirable effect: It decreases the moisture content of the steam at the turbine exit, as can be seen from the T - s diagram (the quality at state 4' is higher than that at state 4).

The temperature to which steam can be superheated is limited, however, by metallurgical considerations. Presently the highest steam temperature allowed at the turbine inlet is about 620°C (1150°F). Any increase in this value depends on improving the present materials or finding new ones that can withstand higher temperatures. Ceramics are very promising in this regard.

Increasing the Boiler Pressure (Increases $T_{\text{high,avg}}$)

Another way of increasing the average temperature during the heat-addition process is to increase the operating pressure of the boiler, which automatically raises the temperature at which boiling takes place. This, in turn, raises the average temperature at which heat is transferred to the steam and thus raises the thermal efficiency of the cycle.

The effect of increasing the boiler pressure on the performance of vapor power cycles is illustrated on a T - s diagram in Fig. 45. Notice that for a fixed turbine inlet temperature, the cycle shifts to the left and the moisture content of steam at the turbine exit increases. This undesirable side effect can be corrected, however, by reheating the steam, as discussed in the next section.

Operating pressures of boilers have gradually increased over the years from about 2.7 MPa (400 psia) in 1922 to over 30 MPa (4500 psia) today, generating enough steam to produce a net power output of 1000 MW or more in a large power plant. Today many modern steam power plants operate at supercritical pressures ($P > 22.06$ MPa) and have thermal efficiencies of about 40 percent for fossil-fuel plants and 34 percent for nuclear plants. There are over 150 supercritical-pressure steam power plants in operation in the United States. The lower efficiencies of nuclear power plants are due to the lower maximum temperatures used in those plants for safety reasons. The T - s diagram of a supercritical Rankine cycle is shown in Fig. 46.

The effects of lowering the condenser pressure, superheating to a higher temperature, and increasing the boiler pressure on the thermal efficiency of the Rankine cycle are illustrated below with an example.

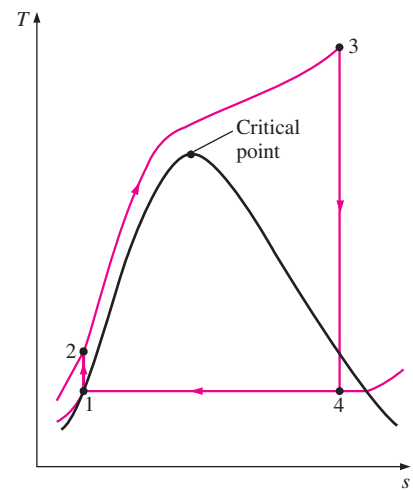

FIGURE 46

A supercritical Rankine cycle.

EXAMPLE 9 Effect of Boiler Pressure and Temperature on Efficiency

Consider a steam power plant operating on the ideal Rankine cycle. Steam enters the turbine at 3 MPa and 350°C and is condensed in the condenser at a pressure of 10 kPa. Determine (a) the thermal efficiency of this power plant, (b) the thermal efficiency if steam is superheated to 600°C instead of 350°C, and (c) the thermal efficiency if the boiler pressure is raised to 15 MPa while the turbine inlet temperature is maintained at 600°C.

Solution A steam power plant operating on the ideal Rankine cycle is considered. The effects of superheating the steam to a higher temperature and raising the boiler pressure on thermal efficiency are to be investigated.

Analysis The T - s diagrams of the cycle for all three cases are given in Fig. 47.

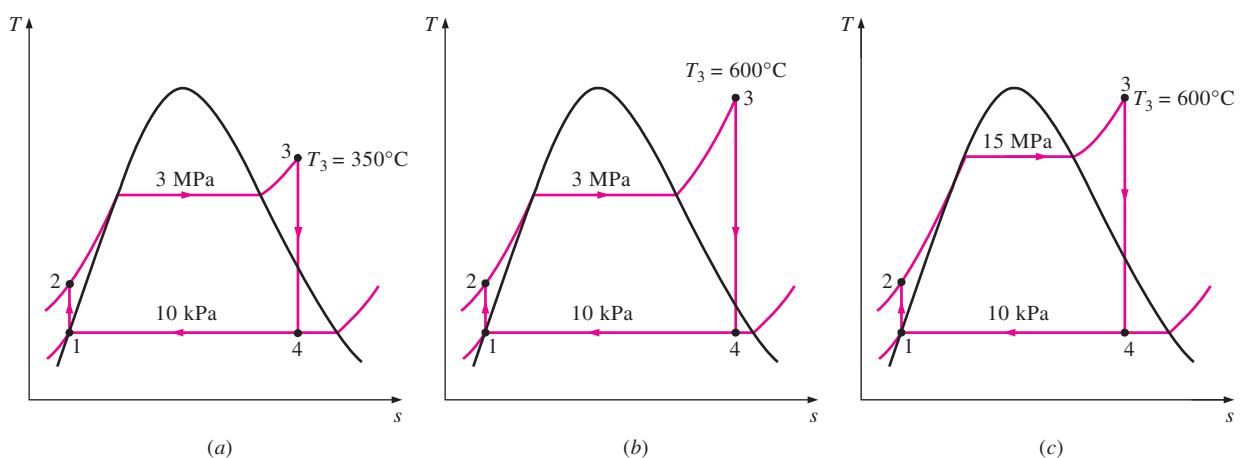

FIGURE 47

T - s diagrams of the three cycles discussed in Example 9.

38 | Fundamentals of Thermal-Fluid Sciences

(a) This is the steam power plant discussed in Example 7, except that the condenser pressure is lowered to 10 kPa. The thermal efficiency is determined in a similar manner:

$$\text{State 1: } \left. \begin{array}{l} P_1 = 10 \text{ kPa} \\ \text{Sat. liquid} \end{array} \right\} \begin{array}{l} h_1 = h_f @ 10 \text{ kPa} = 191.81 \text{ kJ/kg} \\ v_1 = v_f @ 10 \text{ kPa} = 0.00101 \text{ m}^3/\text{kg} \end{array}$$

$$\text{State 2: } \begin{array}{l} P_2 = 3 \text{ MPa} \\ s_2 = s_1 \end{array}$$

$$w_{\text{pump,in}} = v_1(P_2 - P_1) = (0.00101 \text{ m}^3/\text{kg})[(3000 - 10) \text{ kPa}] \left(\frac{1 \text{ kJ}}{1 \text{ kPa} \cdot \text{m}^3} \right)$$

$$= 3.02 \text{ kJ/kg}$$

$$h_2 = h_1 + w_{\text{pump,in}} = (191.81 + 3.02) \text{ kJ/kg} = 194.83 \text{ kJ/kg}$$

$$\text{State 3: } \left. \begin{array}{l} P_3 = 3 \text{ MPa} \\ T_3 = 350^\circ\text{C} \end{array} \right\} \begin{array}{l} h_3 = 3116.1 \text{ kJ/kg} \\ s_3 = 6.7450 \text{ kJ/kg} \cdot \text{K} \end{array}$$

$$\text{State 4: } \begin{array}{l} P_4 = 10 \text{ kPa} \quad (\text{sat. mixture}) \\ s_4 = s_3 \end{array}$$

$$x_4 = \frac{s_4 - s_f}{s_{fg}} = \frac{6.7450 - 0.6492}{7.4996} = 0.8128$$

Thus,

$$h_4 = h_f + x_4 h_{fg} = 191.81 + 0.8128(2392.1) = 2136.1 \text{ kJ/kg}$$

$$q_{\text{in}} = h_3 - h_2 = (3116.1 - 194.83) \text{ kJ/kg} = 2921.3 \text{ kJ/kg}$$

$$q_{\text{out}} = h_4 - h_1 = (2136.1 - 191.81) \text{ kJ/kg} = 1944.3 \text{ kJ/kg}$$

and

$$\eta_{\text{th}} = 1 - \frac{q_{\text{out}}}{q_{\text{in}}} = 1 - \frac{1944.3 \text{ kJ/kg}}{2921.3 \text{ kJ/kg}} = \mathbf{0.334 \text{ or } 33.4\%}$$

Therefore, the thermal efficiency increases from 26.0 to 33.4 percent as a result of lowering the condenser pressure from 75 to 10 kPa. At the same time, however, the quality of the steam decreases from 88.6 to 81.3 percent (in other words, the moisture content increases from 11.4 to 18.7 percent).

(b) States 1 and 2 remain the same in this case, and the enthalpies at state 3 (3 MPa and 600°C) and state 4 (10 kPa and $s_4 = s_3$) are determined to be

$$h_3 = 3682.8 \text{ kJ/kg}$$

$$h_4 = 2380.3 \text{ kJ/kg} \quad (x_4 = 0.915)$$

Thus,

$$q_{\text{in}} = h_3 - h_2 = 3682.8 - 194.83 = 3488.0 \text{ kJ/kg}$$

$$q_{\text{out}} = h_4 - h_1 = 2380.3 - 191.81 = 2188.5 \text{ kJ/kg}$$

and

$$\eta_{\text{th}} = 1 - \frac{q_{\text{out}}}{q_{\text{in}}} = 1 - \frac{2188.5 \text{ kJ/kg}}{3488.0 \text{ kJ/kg}} = \mathbf{0.373 \text{ or } 37.3\%}$$

Therefore, the thermal efficiency increases from 33.4 to 37.3 percent as a result of superheating the steam from 350 to 600°C. At the same time, the quality of the steam increases from 81.3 to 91.5 percent (in other words, the moisture content decreases from 18.7 to 8.5 percent).

(c) State 1 remains the same in this case, but the other states change. The enthalpies at state 2 (15 MPa and $s_2 = s_1$), state 3 (15 MPa and 600°C), and state 4 (10 kPa and $s_4 = s_3$) are determined in a similar manner to be

$$\begin{aligned}h_2 &= 206.95 \text{ kJ/kg} \\h_3 &= 3583.1 \text{ kJ/kg} \\h_4 &= 2115.3 \text{ kJ/kg} \quad (x_4 = 0.804)\end{aligned}$$

Thus,

$$\begin{aligned}q_{\text{in}} &= h_3 - h_2 = 3583.1 - 206.95 = 3376.2 \text{ kJ/kg} \\q_{\text{out}} &= h_4 - h_1 = 2115.3 - 191.81 = 1923.5 \text{ kJ/kg}\end{aligned}$$

and

$$\eta_{\text{th}} = 1 - \frac{q_{\text{out}}}{q_{\text{in}}} = 1 - \frac{1923.5 \text{ kJ/kg}}{3376.2 \text{ kJ/kg}} = \mathbf{0.430 \text{ or } 43.0\%}$$

Discussion The thermal efficiency increases from 37.3 to 43.0 percent as a result of raising the boiler pressure from 3 to 15 MPa while maintaining the turbine inlet temperature at 600°C. At the same time, however, the quality of the steam decreases from 91.5 to 80.4 percent (in other words, the moisture content increases from 8.5 to 19.6 percent).

13 ■ THE IDEAL REHEAT RANKINE CYCLE

We noted in the last section that increasing the boiler pressure increases the thermal efficiency of the Rankine cycle, but it also increases the moisture content of the steam to unacceptable levels. Then it is natural to ask the following question:

How can we take advantage of the increased efficiencies at higher boiler pressures without facing the problem of excessive moisture at the final stages of the turbine?

Two possibilities come to mind:

1. Superheat the steam to very high temperatures before it enters the turbine. This would be the desirable solution since the average temperature at which heat is added would also increase, thus increasing the cycle efficiency. This is not a viable solution, however, since it requires raising the steam temperature to metallurgically unsafe levels.
2. Expand the steam in the turbine in two stages, and reheat it in between. In other words, modify the simple ideal Rankine cycle with a **reheat** process. Reheating is a practical solution to the excessive moisture problem in turbines, and it is commonly used in modern steam power plants.

The T - s diagram of the ideal reheat Rankine cycle and the schematic of the power plant operating on this cycle are shown in Fig. 48. The ideal reheat Rankine cycle differs from the simple ideal Rankine cycle in that the

40 | Fundamentals of Thermal-Fluid Sciences

expansion process takes place in two stages. In the first stage (the high-pressure turbine), steam is expanded isentropically to an intermediate pressure and sent back to the boiler where it is reheated at constant pressure, usually to the inlet temperature of the first turbine stage. Steam then expands isentropically in the second stage (low-pressure turbine) to the condenser pressure. Thus the total heat input and the total turbine work output for a reheat cycle become

$$q_{\text{in}} = q_{\text{primary}} + q_{\text{reheat}} = (h_3 - h_2) + (h_5 - h_4) \quad (36)$$

and

$$w_{\text{turb,out}} = w_{\text{turb,I}} + w_{\text{turb,II}} = (h_3 - h_4) + (h_5 - h_6) \quad (37)$$

The incorporation of the single reheat in a modern power plant improves the cycle efficiency by 4 to 5 percent by increasing the average temperature at which heat is transferred to the steam.

The average temperature during the reheat process can be increased by increasing the number of expansion and reheat stages. As the number of stages is increased, the expansion and reheat processes approach an isothermal process at the maximum temperature, as shown in Fig. 49. The use of more than two reheat stages, however, is not practical. The theoretical improvement in efficiency from the second reheat is about half of that which results from a single reheat. If the turbine inlet pressure is not high enough, double reheat would result in superheated exhaust. This is undesirable as it would cause the average temperature for heat rejection to increase and thus the cycle efficiency to decrease. Therefore, double reheat is used only on supercritical-pressure ($P > 22.06$ MPa) power plants. A third reheat stage would increase the cycle efficiency by about half of the improvement attained by the second reheat. This gain is too small to justify the added cost and complexity.

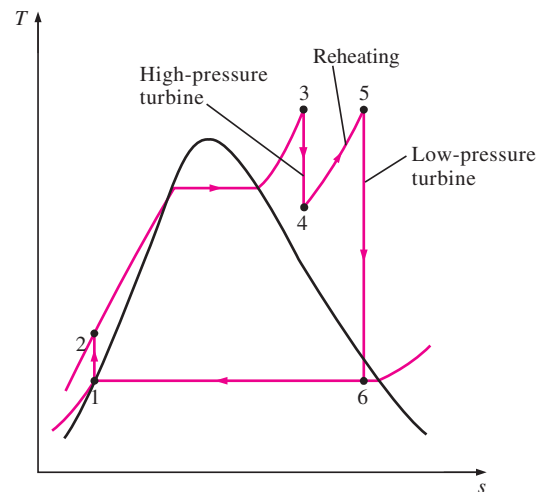
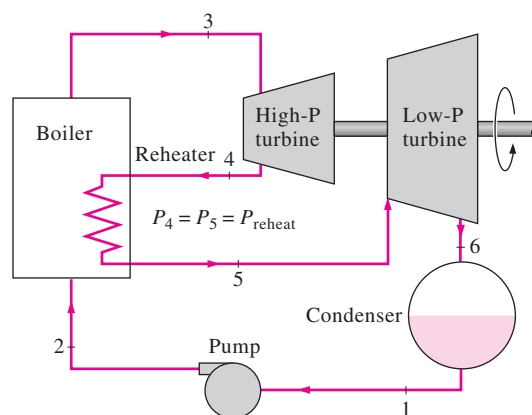

FIGURE 48

The ideal reheat Rankine cycle.

The reheat cycle was introduced in the mid-1920s, but it was abandoned in the 1930s because of the operational difficulties. The steady increase in boiler pressures over the years made it necessary to reintroduce single reheat in the late 1940s and double reheat in the early 1950s.

The reheat temperatures are very close or equal to the turbine inlet temperature. The optimum reheat pressure is about one-fourth of the maximum cycle pressure. For example, the optimum reheat pressure for a cycle with a boiler pressure of 12 MPa is about 3 MPa.

Remember that the sole purpose of the reheat cycle is to reduce the moisture content of the steam at the final stages of the expansion process. If we had materials that could withstand sufficiently high temperatures, there would be no need for the reheat cycle.

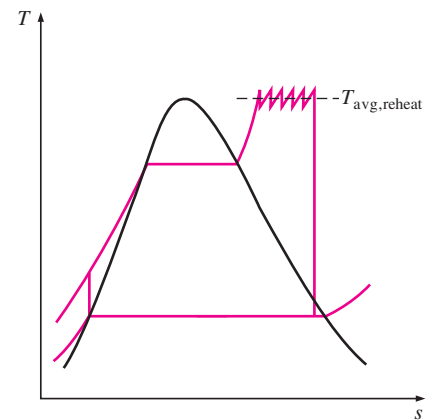

FIGURE 49

The average temperature at which heat is transferred during reheating increases as the number of reheat stages is increased.

EXAMPLE 10 The Ideal Reheat Rankine Cycle

Consider a steam power plant operating on the ideal reheat Rankine cycle. Steam enters the high-pressure turbine at 15 MPa and 600°C and is condensed in the condenser at a pressure of 10 kPa. If the moisture content of the steam at the exit of the low-pressure turbine is not to exceed 10.4 percent, determine (a) the pressure at which the steam should be reheated and (b) the thermal efficiency of the cycle. Assume the steam is reheated to the inlet temperature of the high-pressure turbine.

Solution A steam power plant operating on the ideal reheat Rankine cycle is considered. For a specified moisture content at the turbine exit, the reheat pressure and the thermal efficiency are to be determined.

Assumptions 1 Steady operating conditions exist. 2 Kinetic and potential energy changes are negligible.

Analysis The schematic of the power plant and the T - s diagram of the cycle are shown in Fig. 50. We note that the power plant operates on the ideal reheat Rankine cycle. Therefore, the pump and the turbines are isentropic, there are no pressure drops in the boiler and condenser, and steam leaves the condenser and enters the pump as saturated liquid at the condenser pressure.

(a) The reheat pressure is determined from the requirement that the entropies at states 5 and 6 be the same:

$$\text{State 6: } P_6 = 10 \text{ kPa}$$

$$x_6 = 0.896 \quad (\text{sat. mixture})$$

$$s_6 = s_f + x_6 s_{fg} = 0.6492 + 0.896(7.4996) = 7.3688 \text{ kJ/kg} \cdot \text{K}$$

Also,

$$h_6 = h_f + x_6 h_{fg} = 191.81 + 0.896(2392.1) = 2335.1 \text{ kJ/kg}$$

Thus,

$$\text{State 5: } \left. \begin{array}{l} T_5 = 600^\circ\text{C} \\ s_5 = s_6 \end{array} \right\} \begin{array}{l} P_5 = \mathbf{4.0 \text{ MPa}} \\ h_5 = 3674.9 \text{ kJ/kg} \end{array}$$

Therefore, steam should be reheated at a pressure of 4 MPa or lower to prevent a moisture content above 10.4 percent.

42 | Fundamentals of Thermal-Fluid Sciences

(b) To determine the thermal efficiency, we need to know the enthalpies at all other states:

$$\text{State 1: } \left. \begin{array}{l} P_1 = 10 \text{ kPa} \\ \text{Sat. liquid} \end{array} \right\} \begin{array}{l} h_1 = h_f @ 10 \text{ kPa} = 191.81 \text{ kJ/kg} \\ v_1 = v_f @ 10 \text{ kPa} = 0.00101 \text{ m}^3/\text{kg} \end{array}$$

$$\text{State 2: } P_2 = 15 \text{ MPa}$$

$$s_2 = s_1$$

$$w_{\text{pump,in}} = v_1(P_2 - P_1) = (0.00101 \text{ m}^3/\text{kg})$$

$$\times [(15,000 - 10) \text{ kPa}] \left(\frac{1 \text{ kJ}}{1 \text{ kPa} \cdot \text{m}^3} \right)$$

$$= 15.14 \text{ kJ/kg}$$

$$h_2 = h_1 + w_{\text{pump,in}} = (191.81 + 15.14) \text{ kJ/kg} = 206.95 \text{ kJ/kg}$$

$$\text{State 3: } \left. \begin{array}{l} P_3 = 15 \text{ MPa} \\ T_3 = 600^\circ\text{C} \end{array} \right\} \begin{array}{l} h_3 = 3583.1 \text{ kJ/kg} \\ s_3 = 6.6796 \text{ kJ/kg} \cdot \text{K} \end{array}$$

$$\text{State 4: } \left. \begin{array}{l} P_4 = 4 \text{ MPa} \\ s_4 = s_3 \end{array} \right\} \begin{array}{l} h_4 = 3155.0 \text{ kJ/kg} \\ (T_4 = 375.5^\circ\text{C}) \end{array}$$

Thus

$$q_{\text{in}} = (h_3 - h_2) + (h_5 - h_4)$$

$$= (3583.1 - 206.95) \text{ kJ/kg} + (3674.9 - 3155.0) \text{ kJ/kg}$$

$$= 3896.1 \text{ kJ/kg}$$

$$q_{\text{out}} = h_6 - h_1 = (2335.1 - 191.81) \text{ kJ/kg}$$

$$= 2143.3 \text{ kJ/kg}$$

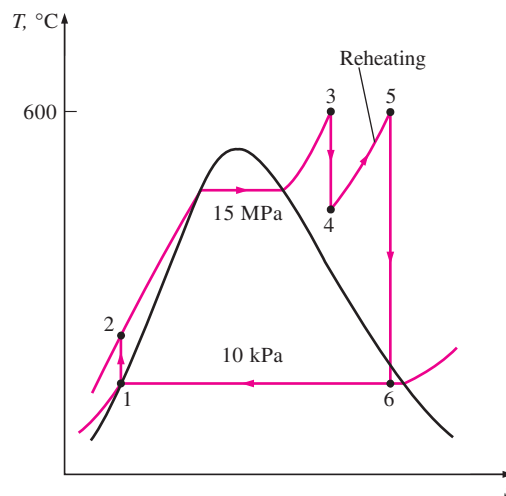
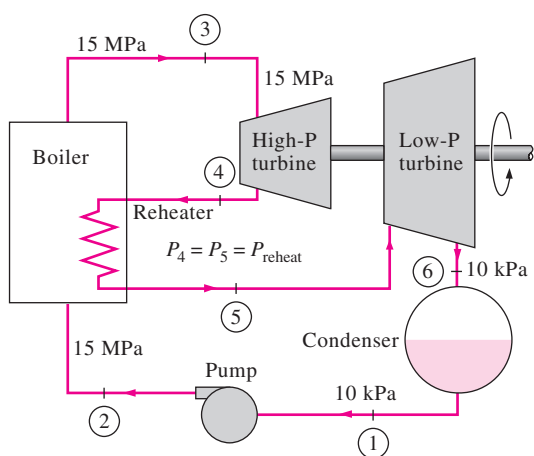

FIGURE 50

Schematic and T - s diagram for Example 10.

and

$$\eta_{\text{th}} = 1 - \frac{q_{\text{out}}}{q_{\text{in}}} = 1 - \frac{2143.3 \text{ kJ/kg}}{3896.1 \text{ kJ/kg}} = \mathbf{0.450 \text{ or } 45.0\%}$$

Discussion This problem was solved in Example 9c for the same pressure and temperature limits but without the reheat process. A comparison of the two results reveals that reheating reduces the moisture content from 19.6 to 10.4 percent while increasing the thermal efficiency from 43.0 to 45.0 percent.

14 ■ REFRIGERATORS AND HEAT PUMPS

We all know from experience that heat flows in the direction of decreasing temperature, that is, from high-temperature regions to low-temperature ones. This heat-transfer process occurs in nature without requiring any devices. The reverse process, however, cannot occur by itself. The transfer of heat from a low-temperature region to a high-temperature one requires special devices called **refrigerators**.

Refrigerators are cyclic devices, and the working fluids used in the refrigeration cycles are called **refrigerants**. A refrigerator is shown schematically in Fig. 51a. Here Q_L is the magnitude of the heat removed from the refrigerated space at temperature T_L , Q_H is the magnitude of the heat rejected to the warm space at temperature T_H , and $W_{\text{net,in}}$ is the net work input to the refrigerator. As discussed in Chap. 6, Q_L and Q_H represent magnitudes and thus are positive quantities.

Another device that transfers heat from a low-temperature medium to a high-temperature one is the **heat pump**. Refrigerators and heat pumps are essentially the same devices; they differ in their objectives only. The objective of a refrigerator is to maintain the refrigerated space at a low temperature by removing heat from it. Discharging this heat to a higher-temperature medium is merely a necessary part of the operation, not the purpose. The objective of a heat pump, however, is to maintain a heated space at a high temperature. This is accomplished by absorbing heat from a low-temperature source, such as well water or cold outside air in winter, and supplying this heat to a warmer medium such as a house (Fig. 51b).

The performance of refrigerators and heat pumps is expressed in terms of the **coefficient of performance (COP)**, defined as

$$\text{COP}_R = \frac{\text{Desired output}}{\text{Required input}} = \frac{\text{Cooling effect}}{\text{Work input}} = \frac{Q_L}{W_{\text{net,in}}} \quad (38)$$

$$\text{COP}_{\text{HP}} = \frac{\text{Desired output}}{\text{Required input}} = \frac{\text{Heating effect}}{\text{Work input}} = \frac{Q_H}{W_{\text{net,in}}} \quad (39)$$

These relations can also be expressed in the rate form by replacing the quantities Q_L , Q_H , and $W_{\text{net,in}}$ by \dot{Q}_L , \dot{Q}_H , and $\dot{W}_{\text{net,in}}$, respectively. Notice that both COP_R and COP_{HP} can be greater than 1. A comparison of Eqs. 38 and 39 reveals that

$$\text{COP}_{\text{HP}} = \text{COP}_R + 1 \quad (40)$$

for fixed values of Q_L and Q_H . This relation implies that $\text{COP}_{\text{HP}} > 1$ since COP_R is a positive quantity. That is, a heat pump functions, at worst, as a

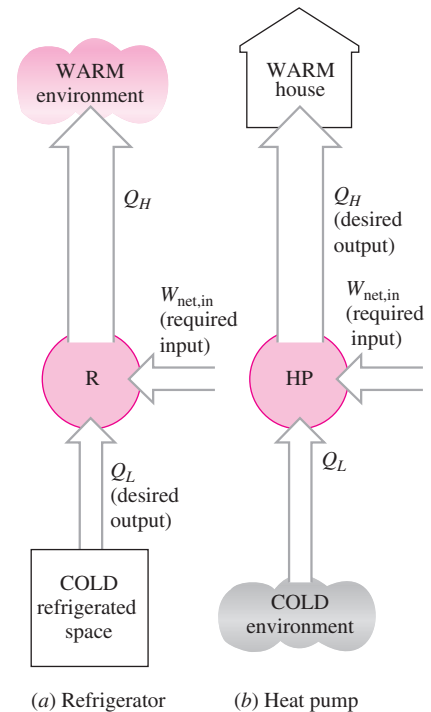

FIGURE 51

The objective of a refrigerator is to remove heat (Q_L) from the cold medium; the objective of a heat pump is to supply heat (Q_H) to a warm medium.

resistance heater, supplying as much energy to the house as it consumes. In reality, however, part of Q_H is lost to the outside air through piping and other devices, and COP_{HP} may drop below unity when the outside air temperature is too low. When this happens, the system normally switches to the fuel (natural gas, propane, oil, etc.) or resistance-heating mode.

The *cooling capacity* of a refrigeration system—that is, the rate of heat removal from the refrigerated space—is often expressed in terms of **tons of refrigeration**. The capacity of a refrigeration system that can freeze 1 ton (2000 lbm) of liquid water at 0°C (32°F) into ice at 0°C in 24 h is said to be 1 ton. One ton of refrigeration is equivalent to 211 kJ/min or 200 Btu/min. The cooling load of a typical 200-m² residence is in the 3-ton (10-kW) range.

15 ■ THE REVERSED CARNOT CYCLE

Recall from Chap. 6 that the Carnot cycle is a totally reversible cycle that consists of two reversible isothermal and two isentropic processes. It has the maximum thermal efficiency for given temperature limits, and it serves as a standard against which actual power cycles can be compared.

Since it is a reversible cycle, all four processes that comprise the Carnot cycle can be reversed. Reversing the cycle does also reverse the directions of any heat and work interactions. The result is a cycle that operates in the counterclockwise direction on a T - s diagram, which is called the **reversed Carnot cycle**. A refrigerator or heat pump that operates on the reversed Carnot cycle is called a **Carnot refrigerator** or a **Carnot heat pump**.

Consider a reversed Carnot cycle executed within the saturation dome of a refrigerant, as shown in Fig. 52. The refrigerant absorbs heat isothermally

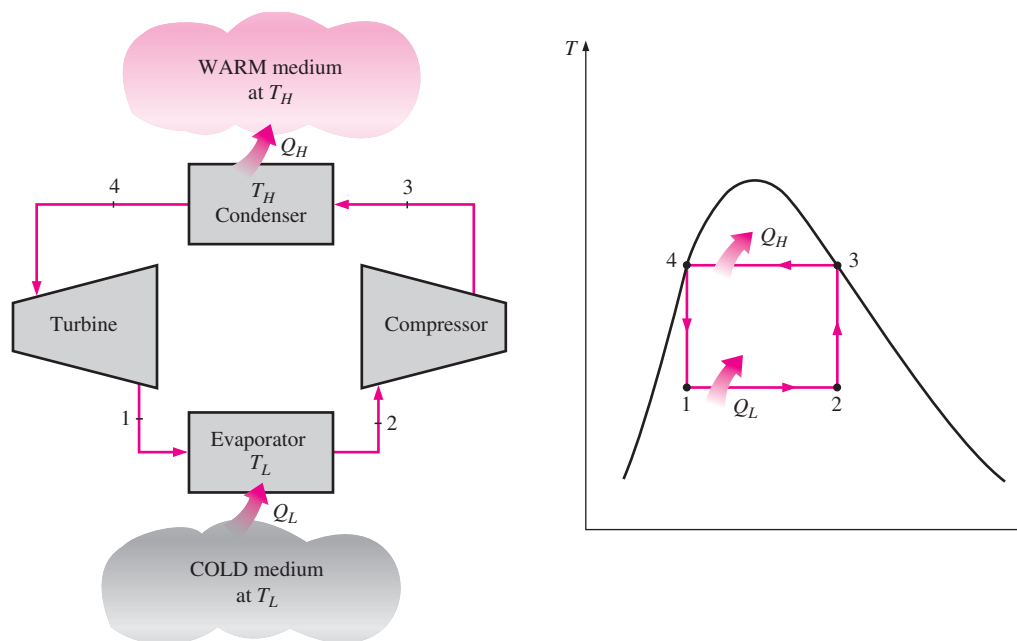

FIGURE 52

Schematic of a Carnot refrigerator and T - s diagram of the reversed Carnot cycle.

from a low-temperature source at T_L in the amount of Q_L (process 1-2), is compressed isentropically to state 3 (temperature rises to T_H), rejects heat isothermally to a high-temperature sink at T_H in the amount of Q_H (process 3-4), and expands isentropically to state 1 (temperature drops to T_L). The refrigerant changes from a saturated vapor state to a saturated liquid state in the condenser during process 3-4.

The coefficients of performance of Carnot refrigerators and heat pumps are expressed in terms of temperatures as

$$\text{COP}_{\text{R,Carnot}} = \frac{1}{T_H/T_L - 1} \quad (41)$$

and

$$\text{COP}_{\text{HP,Carnot}} = \frac{1}{1 - T_L/T_H} \quad (42)$$

Notice that both COPs increase as the difference between the two temperatures decreases, that is, as T_L rises or T_H falls.

The reversed Carnot cycle is the *most efficient* refrigeration cycle operating between two specified temperature levels. Therefore, it is natural to look at it first as a prospective ideal cycle for refrigerators and heat pumps. If we could, we certainly would adapt it as the ideal cycle. As explained below, however, the reversed Carnot cycle is not a suitable model for refrigeration cycles.

The two isothermal heat transfer processes are not difficult to achieve in practice since maintaining a constant pressure automatically fixes the temperature of a two-phase mixture at the saturation value. Therefore, processes 1-2 and 3-4 can be approached closely in actual evaporators and condensers. However, processes 2-3 and 4-1 cannot be approximated closely in practice. This is because process 2-3 involves the compression of a liquid-vapor mixture, which requires a compressor that will handle two phases, and process 4-1 involves the expansion of high-moisture-content refrigerant in a turbine.

It seems as if these problems could be eliminated by executing the reversed Carnot cycle outside the saturation region. But in this case we have difficulty in maintaining isothermal conditions during the heat-absorption and heat-rejection processes. Therefore, we conclude that the reversed Carnot cycle cannot be approximated in actual devices and is not a realistic model for refrigeration cycles. However, the reversed Carnot cycle can serve as a standard against which actual refrigeration cycles are compared.

16 ■ THE IDEAL VAPOR-COMPRESSION REFRIGERATION CYCLE

Many of the impracticalities associated with the reversed Carnot cycle can be eliminated by vaporizing the refrigerant completely before it is compressed and by replacing the turbine with a throttling device, such as an expansion valve or capillary tube. The cycle that results is called the **ideal vapor-compression refrigeration cycle**, and it is shown schematically and on a T - s diagram in Fig. 53. The vapor-compression refrigeration cycle is the most widely used cycle for refrigerators, air-conditioning systems, and heat pumps. It consists of four processes:

- 1-2 Isentropic compression in a compressor
- 2-3 Constant-pressure heat rejection in a condenser

46 | Fundamentals of Thermal-Fluid Sciences

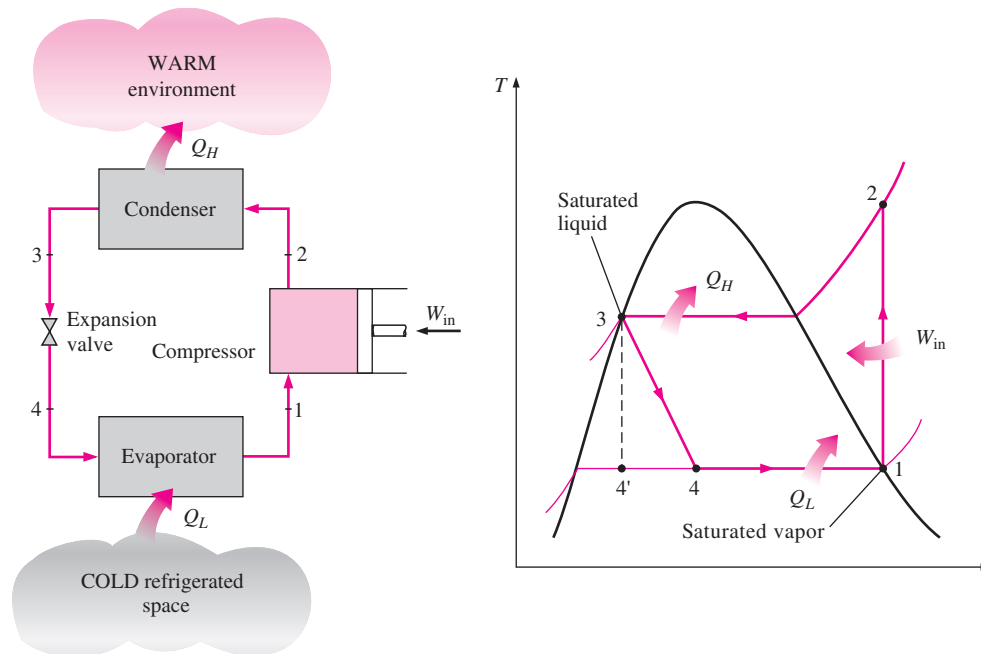

FIGURE 53

Schematic and T - s diagram for the ideal vapor-compression refrigeration cycle.

- 3-4 Throttling in an expansion device
- 4-1 Constant-pressure heat absorption in an evaporator

In an ideal vapor-compression refrigeration cycle, the refrigerant enters the compressor at state 1 as saturated vapor and is compressed isentropically to the condenser pressure. The temperature of the refrigerant increases during this isentropic compression process to well above the temperature of the surrounding medium. The refrigerant then enters the condenser as superheated vapor at state 2 and leaves as saturated liquid at state 3 as a result of heat rejection to the surroundings. The temperature of the refrigerant at this state is still above the temperature of the surroundings.

The saturated liquid refrigerant at state 3 is throttled to the evaporator pressure by passing it through an expansion valve or capillary tube. The temperature of the refrigerant drops below the temperature of the refrigerated space during this process. The refrigerant enters the evaporator at state 4 as a low-quality saturated mixture, and it completely evaporates by absorbing heat from the refrigerated space. The refrigerant leaves the evaporator as saturated vapor and reenters the compressor, completing the cycle.

In a household refrigerator, the tubes in the freezer compartment where heat is absorbed by the refrigerant serves as the evaporator. The coils behind the refrigerator, where heat is dissipated to the kitchen air, serve as the condenser (Fig. 54).

Remember that the area under the process curve on a T - s diagram represents the heat transfer for internally reversible processes. The area under the process curve 4-1 represents the heat absorbed by the refrigerant in the evaporator, and the area under the process curve 2-3 represents the heat rejected in the condenser. A rule of thumb is that the COP improves by 2 to 4 percent for

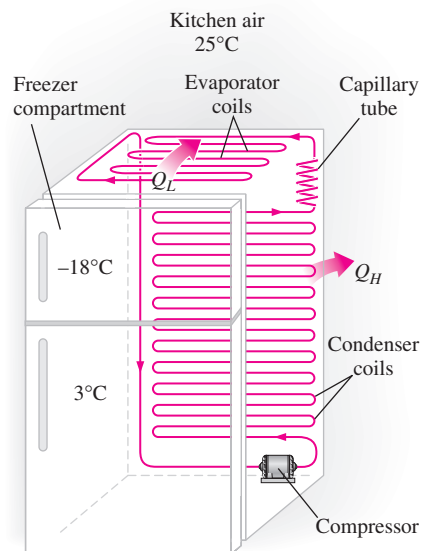

FIGURE 54

An ordinary household refrigerator.

each °C the evaporating temperature is raised or the condensing temperature is lowered.

Another diagram frequently used in the analysis of vapor-compression refrigeration cycles is the P - h diagram, as shown in Fig. 55. On this diagram, three of the four processes appear as straight lines, and the heat transfer in the condenser and the evaporator is proportional to the lengths of the corresponding process curves.

Notice that unlike the ideal cycles discussed before, the ideal vapor-compression refrigeration cycle is not an internally reversible cycle since it involves an irreversible (throttling) process. This process is maintained in the cycle to make it a more realistic model for the actual vapor-compression refrigeration cycle. If the throttling device were replaced by an isentropic turbine, the refrigerant would enter the evaporator at state 4' instead of state 4. As a result, the refrigeration capacity would increase (by the area under process curve 4'-4 in Fig. 53) and the net work input would decrease (by the amount of work output of the turbine). Replacing the expansion valve by a turbine is not practical, however, since the added benefits cannot justify the added cost and complexity.

All four components associated with the vapor-compression refrigeration cycle are steady-flow devices, and thus all four processes that make up the cycle can be analyzed as steady-flow processes. The kinetic and potential energy changes of the refrigerant are usually small relative to the work and heat transfer terms, and therefore they can be neglected. Then the steady-flow energy equation on a unit-mass basis reduces to

$$(q_{\text{in}} - q_{\text{out}}) + (w_{\text{in}} - w_{\text{out}}) = h_e - h_i \quad (43)$$

The condenser and the evaporator do not involve any work, and the compressor can be approximated as adiabatic. Then the COPs of refrigerators and heat pumps operating on the vapor-compression refrigeration cycle can be expressed as

$$\text{COP}_R = \frac{q_L}{w_{\text{net,in}}} = \frac{h_1 - h_4}{h_2 - h_1} \quad (44)$$

and

$$\text{COP}_{\text{HP}} = \frac{q_H}{w_{\text{net,in}}} = \frac{h_2 - h_3}{h_2 - h_1} \quad (45)$$

where $h_1 = h_{g@P_1}$ and $h_3 = h_{f@P_3}$ for the ideal case.

Vapor-compression refrigeration dates back to 1834 when the Englishman Jacob Perkins received a patent for a closed-cycle ice machine using ether or other volatile fluids as refrigerants. A working model of this machine was built, but it was never produced commercially. In 1850, Alexander Twining began to design and build vapor-compression ice machines using ethyl ether, which is a commercially used refrigerant in vapor-compression systems. Initially, vapor-compression refrigeration systems were large and were mainly used for ice making, brewing, and cold storage. They lacked automatic controls and were steam-engine driven. In the 1890s, electric motor-driven smaller machines equipped with automatic controls started to replace the older units, and refrigeration systems began to appear in butcher shops and households. By 1930, the continued improvements made it possible to have vapor-compression refrigeration systems that were relatively efficient, reliable, small, and inexpensive.

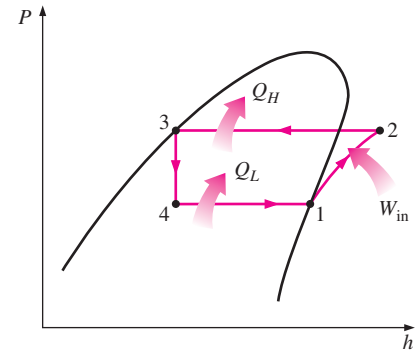

FIGURE 55

The P - h diagram of an ideal vapor-compression refrigeration cycle.

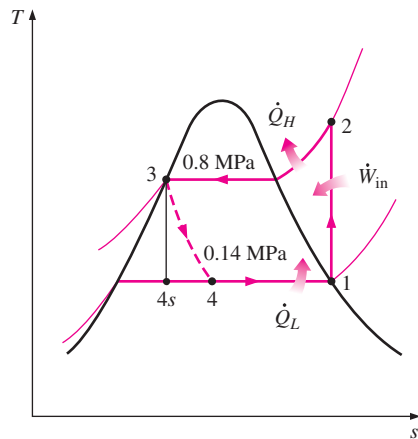

FIGURE 56

T - s diagram of the ideal vapor-compression refrigeration cycle described in Example 11.

EXAMPLE 11 The Ideal Vapor-Compression Refrigeration Cycle

A refrigerator uses refrigerant-134a as the working fluid and operates on an ideal vapor-compression refrigeration cycle between 0.14 and 0.8 MPa. If the mass flow rate of the refrigerant is 0.05 kg/s, determine (a) the rate of heat removal from the refrigerated space and the power input to the compressor, (b) the rate of heat rejection to the environment, and (c) the COP of the refrigerator.

Solution A refrigerator operates on an ideal vapor-compression refrigeration cycle between two specified pressure limits. The rate of refrigeration, the power input, the rate of heat rejection, and the COP are to be determined.

Assumptions 1 Steady operating conditions exist. 2 Kinetic and potential energy changes are negligible.

Analysis The T - s diagram of the refrigeration cycle is shown in Fig. 56. We note that this is an ideal vapor-compression refrigeration cycle, and thus the compressor is isentropic and the refrigerant leaves the condenser as a saturated liquid and enters the compressor as saturated vapor. From the refrigerant-134a tables, the enthalpies of the refrigerant at all four states are determined as follows:

$$P_1 = 0.14 \text{ MPa} \longrightarrow h_1 = h_g @ 0.14 \text{ MPa} = 239.16 \text{ kJ/kg}$$

$$s_1 = s_g @ 0.14 \text{ MPa} = 0.94456 \text{ kJ/kg} \cdot \text{K}$$

$$P_2 = 0.8 \text{ MPa} \left. \begin{array}{l} s_2 = s_1 \end{array} \right\} h_2 = 275.39 \text{ kJ/kg}$$

$$P_3 = 0.8 \text{ MPa} \longrightarrow h_3 = h_f @ 0.8 \text{ MPa} = 95.47 \text{ kJ/kg}$$

$$h_4 \cong h_3 \text{ (throttling)} \longrightarrow h_4 = 95.47 \text{ kJ/kg}$$

(a) The rate of heat removal from the refrigerated space and the power input to the compressor are determined from their definitions:

$$\dot{Q}_L = \dot{m}(h_1 - h_4) = (0.05 \text{ kg/s})[(239.16 - 95.47) \text{ kJ/kg}] = \mathbf{7.18 \text{ kW}}$$

and

$$\dot{W}_{\text{in}} = \dot{m}(h_2 - h_1) = (0.05 \text{ kg/s})[(275.39 - 239.16) \text{ kJ/kg}] = \mathbf{1.81 \text{ kW}}$$

(b) The rate of heat rejection from the refrigerant to the environment is

$$\dot{Q}_H = \dot{m}(h_2 - h_3) = (0.05 \text{ kg/s})[(275.39 - 95.47) \text{ kJ/kg}] = \mathbf{9.0 \text{ kW}}$$

It could also be determined from

$$\dot{Q}_H = \dot{Q}_L + \dot{W}_{\text{in}} = 7.18 + 1.81 = 8.99 \text{ kW}$$

(c) The coefficient of performance of the refrigerator is

$$\text{COP}_R = \frac{\dot{Q}_L}{\dot{W}_{\text{in}}} = \frac{7.18 \text{ kW}}{1.81 \text{ kW}} = \mathbf{3.97}$$

That is, this refrigerator removes about 4 units of thermal energy from the refrigerated space for each unit of electric energy it consumes.

Discussion It would be interesting to see what happens if the throttling valve were replaced by an isentropic turbine. The enthalpy at state 4s (the turbine exit with $P_{4s} = 0.14 \text{ MPa}$, and $s_{4s} = s_3 = 0.35404 \text{ kJ/kg} \cdot \text{K}$) is 88.94 kJ/kg,

and the turbine would produce 0.33 kW of power. This would decrease the power input to the refrigerator from 1.81 to 1.48 kW and increase the rate of heat removal from the refrigerated space from 7.18 to 7.51 kW. As a result, the COP of the refrigerator would increase from 3.97 to 5.07, an increase of 28 percent.

17 ■ ACTUAL VAPOR-COMPRESSION REFRIGERATION CYCLE

An actual vapor-compression refrigeration cycle differs from the ideal one in several ways, owing mostly to the irreversibilities that occur in various components. Two common sources of irreversibilities are fluid friction (causes pressure drops) and heat transfer to or from the surroundings. The T - s diagram of an actual vapor-compression refrigeration cycle is shown in Fig. 57.

In the ideal cycle, the refrigerant leaves the evaporator and enters the compressor as *saturated vapor*. In practice, however, it may not be possible to control the state of the refrigerant so precisely. Instead, it is easier to design the system so that the refrigerant is slightly superheated at the compressor inlet. This slight overdesign ensures that the refrigerant is completely vaporized when it enters the compressor. Also, the line connecting

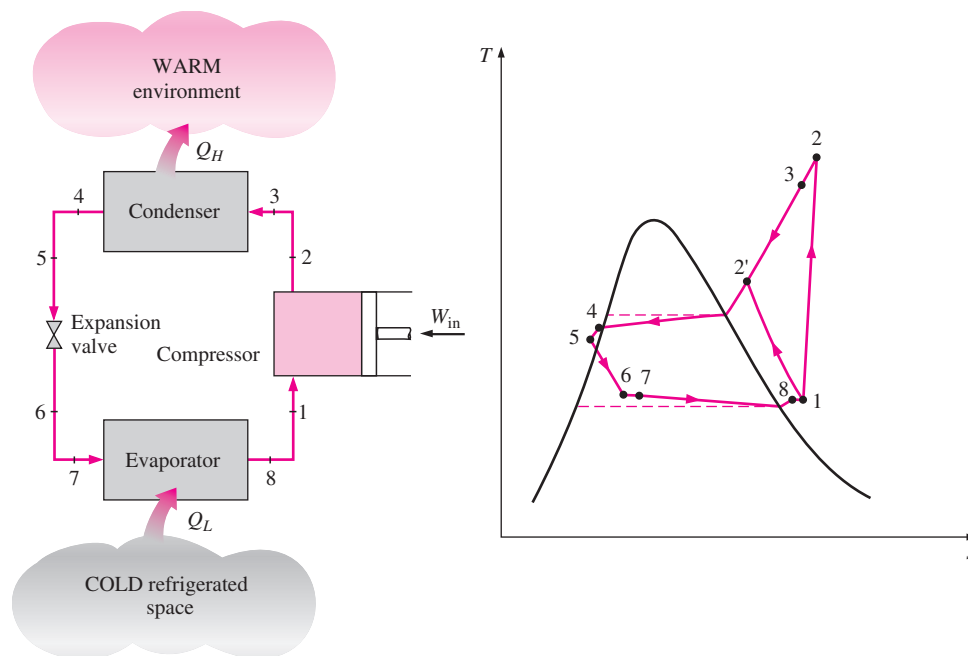

FIGURE 57

Schematic and T - s diagram for the actual vapor-compression refrigeration cycle.

the evaporator to the compressor is usually very long; thus the pressure drop caused by fluid friction and heat transfer from the surroundings to the refrigerant can be very significant. The result of superheating, heat gain in the connecting line, and pressure drops in the evaporator and the connecting line is an increase in the specific volume, thus an increase in the power input requirements to the compressor since steady-flow work is proportional to the specific volume.

The *compression process* in the ideal cycle is internally reversible and adiabatic, and thus isentropic. The actual compression process, however, involves frictional effects, which increase the entropy, and heat transfer, which may increase or decrease the entropy, depending on the direction. Therefore, the entropy of the refrigerant may increase (process 1-2) or decrease (process 1-2') during an actual compression process, depending on which effects dominate. The compression process 1-2' may be even more desirable than the isentropic compression process since the specific volume of the refrigerant and thus the work input requirement are smaller in this case. Therefore, the refrigerant should be cooled during the compression process whenever it is practical and economical to do so.

In the ideal case, the refrigerant is assumed to leave the condenser as *saturated liquid* at the compressor exit pressure. In reality, however, it is unavoidable to have some pressure drop in the condenser as well as in the lines connecting the condenser to the compressor and to the throttling valve. Also, it is not easy to execute the condensation process with such precision that the refrigerant is a saturated liquid at the end, and it is undesirable to route the refrigerant to the throttling valve before the refrigerant is completely condensed. Therefore, the refrigerant is subcooled somewhat before it enters the throttling valve. We do not mind this at all, however, since the refrigerant in this case enters the evaporator with a lower enthalpy and thus can absorb more heat from the refrigerated space. The throttling valve and the evaporator are usually located very close to each other, so the pressure drop in the connecting line is small.

EXAMPLE 12 The Actual Vapor-Compression Refrigeration Cycle

Refrigerant-134a enters the compressor of a refrigerator as superheated vapor at 0.14 MPa and -10°C at a rate of 0.05 kg/s and leaves at 0.8 MPa and 50°C . The refrigerant is cooled in the condenser to 26°C and 0.72 MPa and is throttled to 0.15 MPa. Disregarding any heat transfer and pressure drops in the connecting lines between the components, determine (a) the rate of heat removal from the refrigerated space and the power input to the compressor, (b) the isentropic efficiency of the compressor, and (c) the coefficient of performance of the refrigerator.

Solution A refrigerator operating on a vapor-compression cycle is considered. The rate of refrigeration, the power input, the compressor efficiency, and the COP are to be determined.

Assumptions 1 Steady operating conditions exist. 2 Kinetic and potential energy changes are negligible.

Analysis The T - s diagram of the refrigeration cycle is shown in Fig. 58. We note that the refrigerant leaves the condenser as a compressed liquid and enters the compressor as superheated vapor. The enthalpies of the refrigerant at various states are determined from the refrigerant tables to be

$$\left. \begin{array}{l} P_1 = 0.14 \text{ MPa} \\ T_1 = -10^\circ\text{C} \end{array} \right\} h_1 = 246.36 \text{ kJ/kg}$$

$$\left. \begin{array}{l} P_2 = 0.8 \text{ MPa} \\ T_2 = 50^\circ\text{C} \end{array} \right\} h_2 = 286.69 \text{ kJ/kg}$$

$$\left. \begin{array}{l} P_3 = 0.72 \text{ MPa} \\ T_3 = 26^\circ\text{C} \end{array} \right\} h_3 \cong h_{f@26^\circ\text{C}} = 87.83 \text{ kJ/kg}$$

$$h_4 \cong h_3 \text{ (throttling)} \longrightarrow h_4 = 87.83 \text{ kJ/kg}$$

(a) The rate of heat removal from the refrigerated space and the power input to the compressor are determined from their definitions:

$$\dot{Q}_L = \dot{m}(h_1 - h_4) = (0.05 \text{ kg/s})[(246.36 - 87.83) \text{ kJ/kg}] = \mathbf{7.93 \text{ kW}}$$

and

$$\dot{W}_{\text{in}} = \dot{m}(h_2 - h_1) = (0.05 \text{ kg/s})[(286.69 - 246.36) \text{ kJ/kg}] = \mathbf{2.02 \text{ kW}}$$

(b) The isentropic efficiency of the compressor is determined from

$$\eta_c \cong \frac{h_{2s} - h_1}{h_2 - h_1}$$

where the enthalpy at state $2s$ ($P_{2s} = 0.8 \text{ MPa}$ and $s_{2s} = s_1 = 0.9724 \text{ kJ/kg} \cdot \text{K}$) is 284.21 kJ/kg . Thus,

$$\eta_c = \frac{284.21 - 246.36}{286.69 - 246.36} = \mathbf{0.939 \text{ or } 93.9\%}$$

(c) The coefficient of performance of the refrigerator is

$$\text{COP}_R = \frac{\dot{Q}_L}{\dot{W}_{\text{in}}} = \frac{7.93 \text{ kW}}{2.02 \text{ kW}} = \mathbf{3.93}$$

Discussion This problem is identical to the one worked out in Example 11, except that the refrigerant is slightly superheated at the compressor inlet and subcooled at the condenser exit. Also, the compressor is not isentropic. As a result, the heat removal rate from the refrigerated space increases (by 10.4 percent), but the power input to the compressor increases even more (by 11.6 percent). Consequently, the COP of the refrigerator decreases from 3.97 to 3.93.

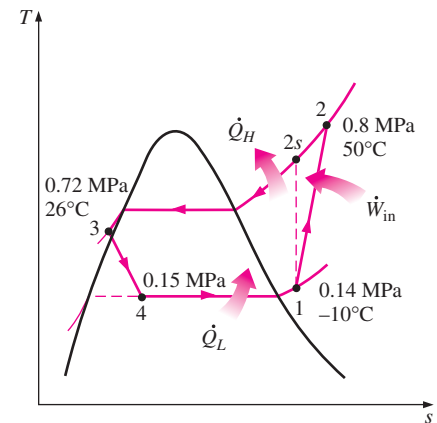

FIGURE 58

T - s diagram for Example 12.

18 ■ SELECTING THE RIGHT REFRIGERANT

When designing a refrigeration system, there are several refrigerants from which to choose, such as chlorofluorocarbons (CFCs), ammonia, hydrocarbons (propane, ethane, ethylene, etc.), carbon dioxide, air (in the air-conditioning of aircraft), and even water (in applications above the freezing point).

52 | Fundamentals of Thermal-Fluid Sciences

The right choice of refrigerant depends on the situation at hand. Of these, refrigerants such as R-11, R-12, R-22, R-134a, and R-502 account for over 90 percent of the market in the United States.

Ethyl ether was the first commercially used refrigerant in vapor-compression systems in 1850, followed by ammonia, carbon dioxide, methyl chloride, sulphur dioxide, butane, ethane, propane, isobutane, gasoline, and chlorofluorocarbons, among others.

The industrial and heavy-commercial sectors were very satisfied with *ammonia*, and still are, although ammonia is toxic. The advantages of ammonia over other refrigerants are its low cost, higher COPs (and thus lower energy cost), more favorable thermodynamic and transport properties and thus higher heat transfer coefficients (requires smaller and lower-cost heat exchangers), greater detectability in the event of a leak, and no effect on the ozone layer. The major drawback of ammonia is its toxicity, which makes it unsuitable for domestic use. Ammonia is predominantly used in food refrigeration facilities such as the cooling of fresh fruits, vegetables, meat, and fish; refrigeration of beverages and dairy products such as beer, wine, milk, and cheese; freezing of ice cream and other foods; ice production; and low-temperature refrigeration in the pharmaceutical and other process industries.

It is remarkable that the early refrigerants used in the light-commercial and household sectors such as sulfur dioxide, ethyl chloride, and methyl chloride were highly toxic. The widespread publicity of a few instances of leaks that resulted in serious illnesses and death in the 1920s caused a public cry to ban or limit the use of these refrigerants, creating a need for the development of a safe refrigerant for household use. At the request of Frigidaire Corporation, General Motors' research laboratory developed R-21, the first member of the CFC family of refrigerants, within three days in 1928. Of several CFCs developed, the research team settled on R-12 as the refrigerant most suitable for commercial use and gave the CFC family the trade name "Freon." Commercial production of R-11 and R-12 was started in 1931 by a company jointly formed by General Motors and E. I. du Pont de Nemours and Co., Inc. The versatility and low cost of CFCs made them the refrigerants of choice. CFCs were also widely used in aerosols, foam insulations, and the electronic industry as solvents to clean computer chips.

R-11 is used primarily in large-capacity water chillers serving air-conditioning systems in buildings. R-12 is used in domestic refrigerators and freezers, as well as automotive air conditioners. R-22 is used in window air conditioners, heat pumps, air conditioners of commercial buildings, and large industrial refrigeration systems, and offers strong competition to ammonia. R-502 (a blend of R-115 and R-22) is the dominant refrigerant used in commercial refrigeration systems such as those in supermarkets because it allows low temperatures at evaporators while operating at single-stage compression.

The ozone crisis has caused a major stir in the refrigeration and air-conditioning industry and has triggered a critical look at the refrigerants in use. It was realized in the mid-1970s that CFCs allow more ultraviolet radiation into the earth's atmosphere by destroying the protective ozone layer and thus contributing to the greenhouse effect that causes global warming. As a result, the use of some CFCs is banned by international treaties. Fully halogenated CFCs (such as R-11, R-12, and R-115) do the most damage to the ozone layer. The nonfully halogenated refrigerants such as R-22 have

about 5 percent of the ozone-depleting capability of R-12. Refrigerants that are friendly to the ozone layer that protects the earth from harmful ultraviolet rays have been developed. The once popular refrigerant R-12 has largely been replaced by the recently developed chlorine-free R-134a.

Two important parameters that need to be considered in the selection of a refrigerant are the temperatures of the two media (the refrigerated space and the environment) with which the refrigerant exchanges heat.

To have heat transfer at a reasonable rate, a temperature difference of 5 to 10°C should be maintained between the refrigerant and the medium with which it is exchanging heat. If a refrigerated space is to be maintained at -10°C , for example, the temperature of the refrigerant should remain at about -20°C while it absorbs heat in the evaporator. The lowest pressure in a refrigeration cycle occurs in the evaporator, and this pressure should be above atmospheric pressure to prevent any air leakage into the refrigeration system. Therefore, a refrigerant should have a saturation pressure of 1 atm or higher at -20°C in this particular case. Ammonia and R-134a are two such substances.

The temperature (and thus the pressure) of the refrigerant on the condenser side depends on the medium to which heat is rejected. Lower temperatures in the condenser (thus higher COPs) can be maintained if the refrigerant is cooled by liquid water instead of air. The use of water cooling cannot be justified economically, however, except in large industrial refrigeration systems. The temperature of the refrigerant in the condenser cannot fall below the temperature of the cooling medium (about 20°C for a household refrigerator), and the saturation pressure of the refrigerant at this temperature should be well below its critical pressure if the heat rejection process is to be approximately isothermal. If no single refrigerant can meet the temperature requirements, then two or more refrigeration cycles with different refrigerants can be used in series. Such a refrigeration system is called a *cascade system* and is discussed later in this chapter.

Other desirable characteristics of a refrigerant include being nontoxic, noncorrosive, nonflammable, and chemically stable; having a high enthalpy of vaporization (minimizes the mass flow rate); and, of course, being available at low cost.

In the case of heat pumps, the minimum temperature (and pressure) for the refrigerant may be considerably higher since heat is usually extracted from media that are well above the temperatures encountered in refrigeration systems.

19 ■ HEAT PUMP SYSTEMS

Heat pumps are generally more expensive to purchase and install than other heating systems, but they save money in the long run in some areas because they lower the heating bills. Despite their relatively higher initial costs, the popularity of heat pumps is increasing. About one-third of all single-family homes built in the United States in the last decade are heated by heat pumps.

The most common energy source for heat pumps is atmospheric air (air-to-air systems), although water and soil are also used. The major problem with air-source systems is *frosting*, which occurs in humid climates when the temperature falls below 2 to 5°C . The frost accumulation on the evaporator coils is highly undesirable since it seriously disrupts heat transfer. The coils can be defrosted, however, by reversing the heat pump cycle (running

54 | Fundamentals of Thermal-Fluid Sciences

it as an air conditioner). This results in a reduction in the efficiency of the system. Water-source systems usually use well water from depths of up to 80 m in the temperature range of 5 to 18°C, and they do not have a frosting problem. They typically have higher COPs but are more complex and require easy access to a large body of water such as underground water. Ground-source systems are also rather involved since they require long tubing placed deep in the ground where the soil temperature is relatively constant. The COP of heat pumps usually ranges between 1.5 and 4, depending on the particular system used and the temperature of the source. A new class of recently developed heat pumps that use variable-speed electric motor drives are at least twice as energy efficient as their predecessors.

Both the capacity and the efficiency of a heat pump fall significantly at low temperatures. Therefore, most air-source heat pumps require a supplementary heating system such as electric resistance heaters or an oil or gas furnace. Since water and soil temperatures do not fluctuate much, supplementary heating may not be required for water-source or ground-source systems. However, the heat pump system must be large enough to meet the maximum heating load.

Heat pumps and air conditioners have the same mechanical components. Therefore, it is not economical to have two separate systems to meet the heating and cooling requirements of a building. One system can be used as a heat pump in winter and an air conditioner in summer. This is accomplished by adding a reversing valve to the cycle, as shown in Fig. 59. As a result of this modification, the condenser of the heat pump (located indoors) functions as the evaporator of the air conditioner in summer. Also, the evaporator of the heat pump (located outdoors) serves as the condenser of the air

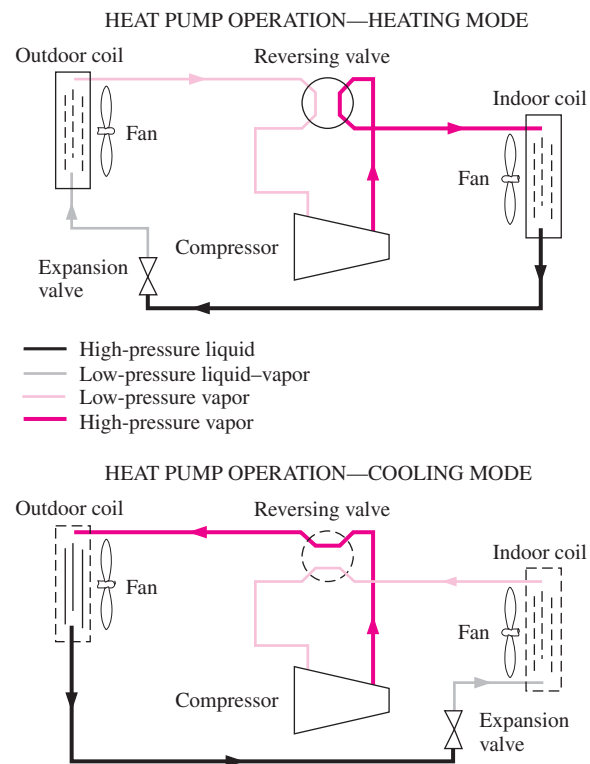
**FIGURE 59**

A heat pump can be used to heat a house in winter and to cool it in summer.

conditioner. This feature increases the competitiveness of the heat pump. Such dual-purpose units are commonly used in motels.

Heat pumps are most competitive in areas that have a large cooling load during the cooling season and a relatively small heating load during the heating season, such as in the southern parts of the United States. In these areas, the heat pump can meet the entire cooling and heating needs of residential or commercial buildings. The heat pump is least competitive in areas where the heating load is very large and the cooling load is small, such as in the northern parts of the United States.

SUMMARY

The most efficient cycle operating between a heat source at temperature T_H and a sink at temperature T_L is the Carnot cycle, and its thermal efficiency is given by

$$\eta_{\text{th, Carnot}} = 1 - \frac{T_L}{T_H}$$

The actual gas cycles are rather complex. The approximations used to simplify the analysis are known as the *air-standard assumptions*. Under these assumptions, all the processes are assumed to be internally reversible; the working fluid is assumed to be air, which behaves as an ideal gas; and the combustion and exhaust processes are replaced by heat-addition and heat-rejection processes, respectively. The air-standard assumptions are called *cold-air-standard assumptions* if, in addition, air is assumed to have constant specific heats at room temperature.

In reciprocating engines, the *compression ratio* r and the *mean effective pressure* MEP are defined as

$$r = \frac{V_{\text{max}}}{V_{\text{min}}} = \frac{V_{\text{BDC}}}{V_{\text{TDC}}}$$

$$\text{MEP} = \frac{w_{\text{net}}}{V_{\text{max}} - V_{\text{min}}}$$

The *Otto cycle* is the ideal cycle for the spark-ignition reciprocating engines, and it consists of four internally reversible processes: isentropic compression, constant-volume heat addition, isentropic expansion, and constant-volume heat rejection. Under cold-air-standard assumptions, the thermal efficiency of the ideal Otto cycle is

$$\eta_{\text{th, Otto}} = 1 - \frac{1}{r^{k-1}}$$

where r is the compression ratio and k is the specific heat ratio c_p/c_v .

The *Diesel cycle* is the ideal cycle for the compression-ignition reciprocating engines. It is very similar to the Otto cycle, except that the constant-volume heat-addition process is replaced by a constant-pressure heat-addition process. Its thermal efficiency under cold-air-standard assumptions is

$$\eta_{\text{th, Diesel}} = 1 - \frac{1}{r^{k-1}} \left[\frac{r_c^k - 1}{k(r_c - 1)} \right]$$

where r_c is the *cutoff ratio*, defined as the ratio of the cylinder volumes after and before the combustion process.

The ideal cycle for modern gas-turbine engines is the *Brayton cycle*, which is made up of four internally reversible processes: isentropic compression, constant-pressure heat addition, isentropic expansion, and constant-pressure heat rejection. Under cold-air-standard assumptions, its thermal efficiency is

$$\eta_{\text{th, Brayton}} = 1 - \frac{1}{r_p^{(k-1)/k}}$$

where $r_p = P_{\text{max}}/P_{\text{min}}$ is the pressure ratio and k is the specific heat ratio. The thermal efficiency of the simple Brayton cycle increases with the pressure ratio.

The deviation of the actual compressor and the turbine from the idealized isentropic ones can be accurately accounted for by utilizing their isentropic efficiencies, defined as

$$\eta_C = \frac{w_s}{w_a} \cong \frac{h_{2s} - h_1}{h_{2a} - h_1}$$

and

$$\eta_T = \frac{w_a}{w_s} \cong \frac{h_3 - h_{4a}}{h_3 - h_{4s}}$$

where states 1 and 3 are the inlet states, 2a and 4a are the actual exit states, and 2s and 4s are the isentropic exit states.

In gas-turbine engines, the temperature of the exhaust gas leaving the turbine is often considerably higher than the temperature of the air leaving the compressor. Therefore, the high-pressure air leaving the compressor can be heated by transferring heat to it from the hot exhaust gases in a counter-flow heat exchanger, which is also known as a *regenerator*. The extent to which a regenerator approaches an ideal regenerator is called the *effectiveness* ε and is defined as

$$\varepsilon = \frac{q_{\text{regen, act}}}{q_{\text{regen, max}}}$$

Under cold-air-standard assumptions, the thermal efficiency of an ideal Brayton cycle with regeneration becomes

$$\eta_{\text{th, regen}} = 1 - \left(\frac{T_1}{T_3} \right) (r_p)^{(k-1)/k}$$

where T_1 and T_3 are the minimum and maximum temperatures, respectively, in the cycle.

56 | Fundamentals of Thermal-Fluid Sciences

The *Carnot cycle* is not a suitable model for vapor power cycles because it cannot be approximated in practice. The model cycle for vapor power cycles is the *Rankine cycle*, which is composed of four internally reversible processes: constant-pressure heat addition in a boiler, isentropic expansion in a turbine, constant-pressure heat rejection in a condenser, and isentropic compression in a pump. Steam leaves the condenser as a saturated liquid at the condenser pressure.

The thermal efficiency of the Rankine cycle can be increased by increasing the average temperature at which heat is added to the working fluid and/or by decreasing the average temperature at which heat is rejected to the cooling medium. The average temperature during heat rejection can be decreased by lowering the turbine exit pressure. Consequently, the condenser pressure of most vapor power plants is well below the atmospheric pressure. The average temperature during heat addition can be increased by raising the boiler pressure or by superheating the fluid to high temperatures. There is a limit to the degree of superheating, however, since the fluid temperature is not allowed to exceed a metallurgically safe value.

Superheating has the added advantage of decreasing the moisture content of the steam at the turbine exit. Lowering the exhaust pressure or raising the boiler pressure, however, increases the moisture content. To take advantage of the improved efficiencies at higher boiler pressures and lower condenser pressures, steam is usually *reheated* after expanding partially in the high-pressure turbine. This is done by extracting the steam after partial expansion in the high-pressure turbine, sending it back to the boiler where it is reheated at constant pressure, and returning it to the low-pressure turbine for complete expansion to the condenser pressure. The average temperature during the reheat process, and thus the thermal efficiency of the cycle, can be increased by increasing the number of expansion and reheat stages. As the number of stages is increased, the expansion and reheat processes

approach an isothermal process of expansion at maximum temperature. Reheating also decreases the moisture content at the turbine exit.

The transfer of heat from lower-temperature regions to higher-temperature ones is called *refrigeration*. Devices that produce refrigeration are called *refrigerators*, and the cycles on which they operate are called *refrigeration cycles*. The working fluids used in refrigerators are called *refrigerants*. Refrigerators used for the purpose of heating a space by transferring heat from a cooler medium are called *heat pumps*.

The performance of refrigerators and heat pumps is expressed in terms of *coefficient of performance* (COP), defined as

$$\text{COP}_R = \frac{\text{Desired output}}{\text{Required output}} = \frac{\text{Cooling effect}}{\text{Work input}} = \frac{Q_L}{W_{\text{net, in}}}$$

$$\text{COP}_{\text{HP}} = \frac{\text{Desired output}}{\text{Required output}} = \frac{\text{Heating effect}}{\text{Work input}} = \frac{Q_H}{W_{\text{net, in}}}$$

The standard of comparison for refrigeration cycles is the *reversed Carnot cycle*. A refrigerator or heat pump that operates on the reversed Carnot cycle is called a *Carnot refrigerator* or a *Carnot heat pump*, and their COPs are

$$\text{COP}_{R, \text{Carnot}} = \frac{1}{T_H/T_L - 1}$$

$$\text{COP}_{\text{HP, Carnot}} = \frac{1}{1 - T_L/T_H}$$

The most widely used refrigeration cycle is the *vapor-compression refrigeration cycle*. In an ideal vapor-compression refrigeration cycle, the refrigerant enters the compressor as a saturated vapor and is cooled to the saturated liquid state in the condenser. It is then throttled to the evaporator pressure and vaporizes as it absorbs heat from the refrigerated space.



REFERENCES AND SUGGESTED READINGS

1. ASHRAE, *Handbook of Fundamentals*. Atlanta: American Society of Heating, Refrigerating, and Air-Conditioning Engineers, 1985.
2. R. L. Bannister and G. J. Silvestri. "The Evolution of Central Station Steam Turbines." *Mechanical Engineering*, February 1989, pp. 70–78.
3. R. L. Bannister, G. J. Silvestri, A. Hizume, and T. Fujikawa. "High Temperature Supercritical Steam Turbines." *Mechanical Engineering*, February 1987, pp. 60–65.
4. Y. A. Çengel and M. A. Boles. *Thermodynamics: An Engineering Approach*. 4th ed. New York: McGraw-Hill, 2002.
5. M. M. El-Wakil. *Powerplant Technology*. New York: McGraw-Hill, 1984.
6. *Heat Pump Systems—A Technology Review*. OECD Report, Paris, 1982.
7. L. C. Lichty. *Combustion Engine Processes*. New York: McGraw-Hill, 1967.
8. W. Siuru. "Two-stroke Engines: Cleaner and Meaner." *Mechanical Engineering*, June 1990, pp. 66–69.
9. H. Sorensen. *Energy Conversion Systems*. New York: John Wiley & Sons, 1983.
10. *Steam, Its Generation and Use*. 39th ed. New York: Babcock and Wilcox Co., 1978.
11. W. F. Stoecker and J. W. Jones. *Refrigeration and Air Conditioning*. 2nd ed. New York: McGraw-Hill, 1982.
12. C. F. Taylor. *The Internal Combustion Engine in Theory and Practice*. Cambridge, MA: M.I.T. Press, 1968.
13. J. Weisman and R. Eckart. *Modern Power Plant Engineering*. Englewood Cliffs, NJ: Prentice Hall, 1985.

PROBLEMS*

Actual and Ideal Cycles, Carnot Cycle, Air-Standard Assumptions, Reciprocating Engines

- 1C** Why is the Carnot cycle not suitable as an ideal cycle for all power-producing cyclic devices?
- 2C** How does the thermal efficiency of an ideal cycle, in general, compare to that of a Carnot cycle operating between the same temperature limits?
- 3C** What does the area enclosed by the cycle represent on a P - v diagram? How about on a T - s diagram?
- 4C** What is the difference between air-standard assumptions and the cold-air-standard assumptions?
- 5C** How are the combustion and exhaust processes modeled under the air-standard assumptions?
- 6C** What are the air-standard assumptions?
- 7C** What is the difference between the clearance volume and the displacement volume of reciprocating engines?
- 8C** Define the compression ratio for reciprocating engines.
- 9C** How is the mean effective pressure for reciprocating engines defined?
- 10C** Can the mean effective pressure of an automobile engine in operation be less than the atmospheric pressure?
- 11C** As a car gets older, will its compression ratio change? How about the mean effective pressure?
- 12C** What is the difference between spark-ignition and compression-ignition engines?
- 13C** Define the following terms related to reciprocating engines: stroke, bore, top dead center, and clearance volume.
- 14** Can any ideal gas power cycle have a thermal efficiency greater than 55 percent when using thermal energy reservoirs at 627°C and 17°C ?
- 15** An air-standard cycle with variable specific heats is executed in a closed system and is composed of the following four processes:
- 1-2 Isentropic compression from 100 kPa and 27°C to 800 kPa
 - 2-3 $v = \text{constant}$ heat addition to 1800 K
 - 3-4 Isentropic expansion to 100 kPa
 - 4-1 $P = \text{constant}$ heat rejection to initial state

* Problems designated by a "C" are concept questions, and students are encouraged to answer them all. Problems designated by an "E" are in English units, and the SI users can ignore them. Problems with the  icon are solved using EES, and complete solutions together with parametric studies are included on the enclosed DVD. Problems with the  icon are comprehensive in nature, and are intended to be solved with a computer, preferably using the EES software that accompanies this text.

- (a) Show the cycle on P - v and T - s diagrams.
 - (b) Calculate the net work output per unit mass.
 - (c) Determine the thermal efficiency.
- 16**  Reconsider Prob. 15. Using EES (or other) software, study the effect of varying the temperature after the constant-volume heat addition from 1500 K to 2500 K. Plot the net work output and thermal efficiency as a function of the maximum temperature of the cycle. Plot the T - s and P - v diagrams for the cycle when the maximum temperature of the cycle is 1800 K.
- 17** An air-standard cycle is executed in a closed system and is composed of the following four processes:
- 1-2 Isentropic compression from 100 kPa and 27°C to 1 MPa
 - 2-3 $P = \text{constant}$ heat addition in amount of 2800 kJ/kg
 - 3-4 $v = \text{constant}$ heat rejection to 100 kPa
 - 4-1 $P = \text{constant}$ heat rejection to initial state
- (a) Show the cycle on P - v and T - s diagrams.
 - (b) Calculate the maximum temperature in the cycle.
 - (c) Determine the thermal efficiency.

Assume constant specific heats at room temperature.

Answers: (b) 3360 K, (c) 21.0 percent

- 18E** An air-standard cycle with variable specific heats is executed in a closed system and is composed of the following four processes:
- 1-2 $v = \text{constant}$ heat addition from 14.7 psia and 80°F in the amount of 300 Btu/lbm
 - 2-3 $P = \text{constant}$ heat addition to 3200 R
 - 3-4 Isentropic expansion to 14.7 psia
 - 4-1 $P = \text{constant}$ heat rejection to initial state
- (a) Show the cycle on P - v and T - s diagrams.
 - (b) Calculate the total heat input per unit mass.
 - (c) Determine the thermal efficiency.

Answers: (b) 612.4 Btu/lbm, (c) 24.2 percent

- 19E** Repeat Prob. 18E using constant specific heats at room temperature.
- 20** An air-standard cycle is executed in a closed system with 0.004 kg of air and consists of the following three processes:
- 1-2 Isentropic compression from 100 kPa and 27°C to 1 MPa
 - 2-3 $P = \text{constant}$ heat addition in the amount of 2.76 kJ
 - 3-1 $P = c_1 v + c_2$ heat rejection to initial state (c_1 and c_2 are constants)
- (a) Show the cycle on P - v and T - s diagrams.
 - (b) Calculate the heat rejected.
 - (c) Determine the thermal efficiency.

Assume constant specific heats at room temperature.

Answers: (b) 1.679 kJ, (c) 39.2 percent

58 | Fundamentals of Thermal-Fluid Sciences

21 An air-standard cycle with variable specific heats is executed in a closed system with 0.003 kg of air and consists of the following three processes:

1-2 $v = \text{constant}$ heat addition from 95 kPa and 17°C to 380 kPa

2-3 Isentropic expansion to 95 kPa

3-1 $P = \text{constant}$ heat rejection to initial state

(a) Show the cycle on P - v and T - s diagrams.

(b) Calculate the net work per cycle, in kJ.

(c) Determine the thermal efficiency.

22 Repeat Prob. 21 using constant specific heats at room temperature.

23 Consider a Carnot cycle executed in a closed system with 0.003 kg of air. The temperature limits of the cycle are 300 and 900 K, and the minimum and maximum pressures that occur during the cycle are 20 and 2000 kPa. Assuming constant specific heats, determine the net work output per cycle.

24 Consider a Carnot cycle executed in a closed system with air as the working fluid. The maximum pressure in the cycle is 800 kPa while the maximum temperature is 750 K. If the entropy increase during the isothermal heat rejection process is 0.25 kJ/kg · K and the net work output is 100 kJ/kg, determine (a) the minimum pressure in the cycle, (b) the heat rejection from the cycle, and (c) the thermal efficiency of the cycle. (d) If an actual heat engine cycle operates between the same temperature limits and produces 5200 kW of power for an air flow rate of 90 kg/s, determine the second law efficiency of this cycle.

25 An ideal gas Carnot cycle uses air as the working fluid, receives heat from a heat reservoir at 1027°C, is repeated 1500 times per minute, and has a compression ratio of 12. The compression ratio is defined as the volume ratio during the compression process. Determine the maximum temperature of the low-temperature heat reservoir, the cycle's thermal efficiency, and the amount of heat that must be supplied per cycle if this device is to produce 500 kW of power. *Answers: 481 K, 63.0 percent, 31.8 kJ*

26E The thermal energy reservoirs of an ideal gas Carnot cycle are at 1240°F and 40°F, and the device executing this cycle rejects 100 Btu of heat each time the cycle is executed. Determine the total heat supplied to and the total work produced by this cycle each time it is executed.

Otto Cycle

27C What four processes make up the ideal Otto cycle?

28C How do the efficiencies of the ideal Otto cycle and the Carnot cycle compare for the same temperature limits? Explain.

29C How is the rpm (revolutions per minute) of an actual four-stroke gasoline engine related to the number of thermodynamic cycles? What would your answer be for a two-stroke engine?

30C Are the processes that make up the Otto cycle analyzed as closed-system or steady-flow processes? Why?

31C How does the thermal efficiency of an ideal Otto cycle change with the compression ratio of the engine and the specific heat ratio of the working fluid?

32C Why are high compression ratios not used in spark-ignition engines?

33C An ideal Otto cycle with a specified compression ratio is executed using (a) air, (b) argon, and (c) ethane as the working fluid. For which case will the thermal efficiency be the highest? Why?

34C What is the difference between fuel-injected gasoline engines and diesel engines?

35 An ideal Otto cycle has a compression ratio of 12, takes in air at 100 kPa and 20°C, and is repeated 1000 times per minute. Using constant specific heats at room temperature, determine the thermal efficiency of this cycle and the rate of heat input if the cycle is to produce 200 kW of power.

36 Repeat Prob. 35 for a compression ratio of 10.

37E A spark-ignition engine has a compression ratio of 8, an isentropic compression efficiency of 85 percent, and an isentropic expansion efficiency of 95 percent. At the beginning of the compression, the air in the cylinder is at 13 psia and 60°F. The maximum gas temperature is found to be 2300°F by measurement. Determine the heat supplied per unit mass, the thermal efficiency, and the mean effective pressure of this engine when modeled with the Otto cycle. Use constant specific heats at room temperature. *Answers: 247 Btu/lbm, 47.5 percent, 49.0 psia*

38 The compression ratio of an air-standard Otto cycle is 9.5. Prior to the isentropic compression process, the air is at 100 kPa, 35°C, and 600 cm³. The temperature at the end of the isentropic expansion process is 800 K. Using specific heat values at room temperature, determine (a) the highest temperature and pressure in the cycle; (b) the amount of heat transferred in, in kJ; (c) the thermal efficiency; and (d) the mean effective pressure. *Answers: (a) 1969 K, 6072 kPa, (b) 0.59 kJ, (c) 59.4 percent, (d) 652 kPa*

39 Repeat Prob. 38, but replace the isentropic expansion process by a polytropic expansion process with the polytropic exponent $n = 1.35$.

40E An ideal Otto cycle with air as the working fluid has a compression ratio of 8. The minimum and maximum temperatures in the cycle are 540 and 2400 R. Accounting for the variation of specific heats with temperature, determine (a) the amount of heat transferred to the air during the heat-addition process, (b) the thermal efficiency, and (c) the thermal efficiency of a Carnot cycle operating between the same temperature limits.

41E Repeat Prob. 40E using argon as the working fluid.

42 A four-cylinder, four-stroke, 2.2-L gasoline engine operates on the Otto cycle with a compression ratio of 10. The air is at 100 kPa and 60°C at the beginning of the compression process, and the maximum pressure in the cycle is 8 MPa. The compression and expansion processes may be modeled as polytropic with a polytropic constant of 1.3. Using constant specific heats at 850 K, determine (a) the temperature at the end of the expansion process, (b) the net work output and the thermal efficiency, (c) the mean effective pressure, (d) the engine speed for a net power output of 70 kW, and (e) the specific fuel consumption, in g/kWh, defined as the ratio of the mass of the fuel consumed to the net work produced. The air–fuel ratio, defined as the amount of air divided by the amount of fuel intake, is 16.

43E Determine the mean effective pressure of an ideal Otto cycle that uses air as the working fluid; its state at the beginning of the compression is 14 psia and 60°F; its temperature at the end of the combustion is 1500°F; and its compression ratio is 9. Use constant specific heats at room temperature.

44E Determine the rate of heat addition and rejection for the Otto cycle of Prob. 43E when it produces 140 hp and the cycle is repeated 1400 times per minute.

45 When we double the compression ratio of an ideal Otto cycle, what happens to the maximum gas temperature and pressure when the state of the air at the beginning of the compression and the amount of heat addition remain the same? Use constant specific heats at room temperature.

46 In a spark-ignition engine, some cooling occurs as the gas is expanded. This may be modeled by using a polytropic process in lieu of the isentropic process. Determine if the polytropic exponent used in this model will be greater than or less than the isentropic exponent.

47 An ideal Otto cycle has a compression ratio of 7. At the beginning of the compression process, $P_1 = 90$ kPa, $T_1 = 27^\circ\text{C}$, and $V_1 = 0.004$ m³. The maximum cycle temperature is 1127°C. For each repetition of the cycle, calculate the heat rejection and the net work production. Also calculate the thermal efficiency and mean effective pressure for this cycle. Use constant specific heats at room temperature. *Answers: 1.03 kJ, 1.21 kJ, 54.1 percent, 354 kPa*

48 A six-cylinder, 4-L spark-ignition engine operating on the ideal Otto cycle takes in air at 90 kPa and 20°C. The minimum enclosed volume is 15 percent of the maximum enclosed volume. When operated at 2500 rpm, this engine produces 90 hp. Determine the rate of heat addition to this engine. Use constant specific heats at room temperature.

Diesel Cycle

49C How does a diesel engine differ from a gasoline engine?

50C How does the ideal Diesel cycle differ from the ideal Otto cycle?

51C For a specified compression ratio, is a diesel or gasoline engine more efficient?

52C Do diesel or gasoline engines operate at higher compression ratios? Why?

53C What is the cutoff ratio? How does it affect the thermal efficiency of a Diesel cycle?

54 Develop an expression for cutoff ratio r_c which expresses it in terms of $q_{in}/(c_p T_1 r^{k-1})$ for an air-standard Diesel cycle.

55 An ideal Diesel cycle has a compression ratio of 18 and a cutoff ratio of 1.5. Determine the maximum air temperature and the rate of heat addition to this cycle when it produces 200 hp of power; the cycle is repeated 1200 times per minute; and the state of the air at the beginning of the compression is 95 kPa and 17°C. Use constant specific heats at room temperature.

56 Rework Prob. 55 when the isentropic compression efficiency is 90 percent and the isentropic expansion efficiency is 95 percent.

57 An ideal Diesel cycle has a maximum cycle temperature of 2000°C and a cutoff ratio of 1.2. The state of the air at the beginning of the compression is $P_1 = 95$ kPa and $T_1 = 15^\circ\text{C}$. This cycle is executed in a four-stroke, eight-cylinder engine with a cylinder bore of 10 cm and a piston stroke of 12 cm. The minimum volume enclosed in the cylinder is 5 percent of the maximum cylinder volume. Determine the power produced by this engine when it is operated at 1600 rpm. Use constant specific heats at room temperature. *Answer: 105 kW*

58E An air-standard dual cycle has a compression ratio of 20 and a cutoff ratio of 1.3. The pressure ratio during the constant-volume heat addition process is 1.2. Determine the thermal efficiency, amount of heat added, and the maximum gas pressure and temperature when this cycle is operated at 14 psia and 70°F at the beginning of the compression. Use constant specific heats at room temperature.

59E Repeat Prob. 58E if the compression ratio were reduced to 12.

60E An air-standard Diesel cycle has a compression ratio of 18.2. Air is at 80°F and 14.7 psia at the beginning of the compression process and at 3000 R at the end of the heat-addition process. Accounting for the variation of specific heats with temperature, determine (a) the cutoff ratio, (b) the heat rejection per unit mass, and (c) the thermal efficiency.

61E Repeat Prob. 60E using constant specific heats at room temperature.

62 An ideal diesel engine has a compression ratio of 20 and uses air as the working fluid. The state of air at the beginning of the compression process is 95 kPa and 20°C. If the maximum temperature in the cycle is not to exceed 2200 K, determine (a) the thermal efficiency and (b) the mean effective pressure. Assume constant specific heats for air at room temperature. *Answers: (a) 63.5 percent, (b) 933 kPa*

60 | Fundamentals of Thermal-Fluid Sciences

63 Repeat Problem 62, but replace the isentropic expansion process by polytropic expansion process with the polytropic exponent $n = 1.35$.

64  Reconsider Prob. 63. Using EES (or other) software, study the effect of varying the compression ratio from 14 to 24. Plot the net work output, mean effective pressure, and thermal efficiency as a function of the compression ratio. Plot the T - s and P - v diagrams for the cycle when the compression ratio is 20.

65 A four-cylinder two-stroke 2.4-L diesel engine that operates on an ideal Diesel cycle has a compression ratio of 17 and a cutoff ratio of 2.2. Air is at 55°C and 97 kPa at the beginning of the compression process. Using the cold-air-standard assumptions, determine how much power the engine will deliver at 1500 rpm.

66 Repeat Prob. 65 using nitrogen as the working fluid.

67 An air-standard dual cycle has a compression ratio of 18 and a cutoff ratio of 1.1. The pressure ratio during constant-volume heat addition process is 1.1. At the beginning of the compression, $P_1 = 90$ kPa, $T_1 = 18^\circ\text{C}$, and $V_1 = 0.003$ m³. How much power will this cycle produce when it is executed 4000 times per minute? Use constant specific heats at room temperature.

68 Repeat Prob. 67 if the isentropic compression efficiency is 85 percent and the isentropic expansion efficiency is 90 percent. *Answer: 9.26 kW*

69E An ideal dual cycle has a compression ratio of 15 and a cutoff ratio of 1.4. The pressure ratio during constant-volume heat addition process is 1.1. The state of the air at the beginning of the compression is $P_1 = 14.2$ psia and $T_1 = 75^\circ\text{F}$. Calculate the cycle's net specific work, specific heat addition, and thermal efficiency. Use constant specific heats at room temperature.

70 Develop an expression for the thermal efficiency of a dual cycle when operated such that $r_c = r_p$ where r_c is the cutoff ratio and r_p is the pressure ratio during the constant-volume heat addition process. What is the thermal efficiency of such engine when the compression ratio is 20 and $r_p = 2$?

71 How can one change r_p in Prob. 70 so that the same thermal efficiency is maintained when the compression ratio is reduced?

72 A six-cylinder, four-stroke, 4.5-L compression-ignition engine operates on the ideal diesel cycle with a compression ratio of 17. The air is at 95 kPa and 55°C at the beginning of the compression process and the engine speed is 2000 rpm. The engine uses light diesel fuel with a heating value of 42,500 kJ/kg, an air-fuel ratio of 24, and a combustion efficiency of 98 percent. Using constant specific heats at 850 K, determine (a) the maximum temperature in the cycle and the cutoff ratio (b) the net work output per cycle and the thermal efficiency, (c) the mean effective pressure, (d) the net power

output, and (e) the specific fuel consumption, in g/kWh, defined as the ratio of the mass of the fuel consumed to the net work produced. *Answers: (a) 2383 K, 2.7 (b) 4.36 kJ, 0.543, (c) 969 kPa, (d) 72.7 kW, (e) 159 g/kWh*

Ideal and Actual Gas-Turbine (Brayton) Cycles

73C Why are the back work ratios relatively high in gas-turbine engines?

74C What four processes make up the simple ideal Brayton cycle?

75C For fixed maximum and minimum temperatures, what is the effect of the pressure ratio on (a) the thermal efficiency and (b) the net work output of a simple ideal Brayton cycle?

76C What is the back work ratio? What are typical back work ratio values for gas-turbine engines?

77C How do the inefficiencies of the turbine and the compressor affect (a) the back work ratio and (b) the thermal efficiency of a gas-turbine engine?

78E A simple ideal Brayton cycle with air as the working fluid has a pressure ratio of 10. The air enters the compressor at 520 R and the turbine at 2000 R. Accounting for the variation of specific heats with temperature, determine (a) the air temperature at the compressor exit, (b) the back work ratio, and (c) the thermal efficiency.

79  A simple Brayton cycle using air as the working fluid has a pressure ratio of 8. The minimum and maximum temperatures in the cycle are 310 and 1160 K. Assuming an isentropic efficiency of 75 percent for the compressor and 82 percent for the turbine, determine (a) the air temperature at the turbine exit, (b) the net work output, and (c) the thermal efficiency.

80  Reconsider Prob. 79. Using EES (or other) software, allow the mass flow rate, pressure ratio, turbine inlet temperature, and the isentropic efficiencies of the turbine and compressor to vary. Assume the compressor inlet pressure is 100 kPa. Develop a general solution for the problem by taking advantage of the diagram window method for supplying data to EES software.

81 Repeat Prob. 80 using constant specific heats at room temperature.

82 A simple ideal Brayton cycle operates with air with minimum and maximum temperatures of 27°C and 727°C. It is designed so that the maximum cycle pressure is 2000 kPa and the minimum cycle pressure is 100 kPa. Determine the net work produced per unit mass of air each time this cycle is executed and the cycle's thermal efficiency. Use constant specific heats at room temperature.

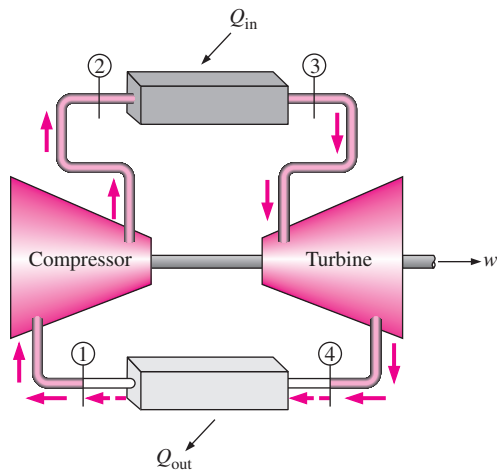

FIGURE P82

- 83** Repeat Prob. 82 when the isentropic efficiency of the turbine is 90 percent.
- 84** Repeat Prob. 82 when the isentropic efficiency of the turbine is 90 percent and that of the compressor is 80 percent.
- 85** Repeat Prob. 82 when the isentropic efficiencies of the turbine and compressor are 90 percent and 80 percent, respectively, and there is a 50-kPa pressure drop across the combustion chamber. *Answers: 7.3 kJ, 3.8 percent*
- 86** Air is used as the working fluid in a simple ideal Brayton cycle that has a pressure ratio of 12, a compressor inlet temperature of 300 K, and a turbine inlet temperature of 1000 K. Determine the required mass flow rate of air for a net power output of 70 MW, assuming both the compressor and the turbine have an isentropic efficiency of (a) 100 percent and (b) 85 percent. Assume constant specific heats at room temperature. *Answers: (a) 352 kg/s, (b) 1037 kg/s*
- 87** A stationary gas-turbine power plant operates on a simple ideal Brayton cycle with air as the working fluid. The air enters the compressor at 95 kPa and 290 K and the turbine at 760 kPa and 1100 K. Heat is transferred to air at a rate of 35,000 kJ/s. Determine the power delivered by this plant (a) assuming constant specific heats at room temperature and (b) accounting for the variation of specific heats with temperature.
- 88** Air enters the compressor of a gas-turbine engine at 300 K and 100 kPa, where it is compressed to 700 kPa and 580 K. Heat is transferred to air in the amount of 950 kJ/kg before it enters the turbine. For a turbine efficiency of 86 percent, determine (a) the fraction of the turbine work output used to drive the compressor and (b) the thermal efficiency. Assume variable specific heats for air.

Power and Refrigeration Cycles | 61

89 Repeat Prob. 78 using constant specific heats at room temperature.

90E A simple ideal Brayton cycle uses argon as the working fluid. At the beginning of the compression, $P_1 = 15$ psia and $T_1 = 80^\circ\text{F}$; the maximum cycle temperature is 1200°F ; and the pressure in the combustion chamber is 150 psia. The argon enters the compressor through a 3 ft^2 opening with a velocity of 200 ft/s. Determine the rate of heat addition to this engine, the power produced, and the cycle's thermal efficiency.

91 An aircraft engine operates on a simple ideal Brayton cycle with a pressure ratio of 10. Heat is added to the cycle at a rate of 500 kW; air passes through the engine at a rate of 1 kg/s; and the air at the beginning of the compression is at 70 kPa and 0°C . Determine the power produced by this engine and its thermal efficiency. Use constant specific heats at room temperature.

92 Repeat Prob. 91 for a pressure ratio of 15.

93 A gas-turbine power plant operates on the simple Brayton cycle between the pressure limits of 100 and 1200 kPa. The working fluid is air, which enters the compressor at 30°C at a rate of $150\text{ m}^3/\text{min}$ and leaves the turbine at 500°C . Using variable specific heats for air and assuming a compressor isentropic efficiency of 82 percent and a turbine isentropic efficiency of 88 percent, determine (a) the net power output, (b) the back work ratio, and (c) the thermal efficiency. *Answers: (a) 659 kW, (b) 0.625, (c) 0.319*

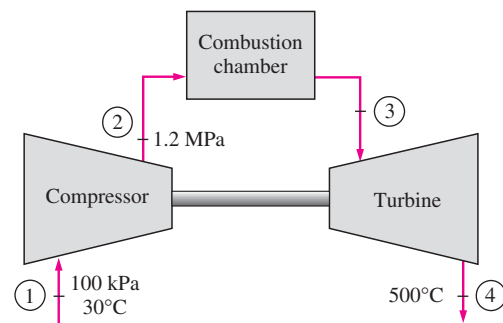

FIGURE P93

Brayton Cycle with Regeneration

94C How does regeneration affect the efficiency of a Brayton cycle, and how does it accomplish it?

95C Somebody claims that at very high pressure ratios, the use of regeneration actually decreases the thermal efficiency of a gas-turbine engine. Is there any truth in this claim? Explain.

96C Define the effectiveness of a regenerator used in gas-turbine cycles.

62 | Fundamentals of Thermal-Fluid Sciences

97C In an ideal regenerator, is the air leaving the compressor heated to the temperature at (a) turbine inlet, (b) turbine exit, (c) slightly above turbine exit?

98C In 1903, Aegidius Elling of Norway designed and built an 11-hp gas turbine that used steam injection between the combustion chamber and the turbine to cool the combustion gases to a safe temperature for the materials available at the time. Currently there are several gas-turbine power plants that use steam injection to augment power and improve thermal efficiency. For example, the thermal efficiency of the General Electric LM5000 gas turbine is reported to increase from 35.8 percent in simple-cycle operation to 43 percent when steam injection is used. Explain why steam injection increases the power output and the efficiency of gas turbines. Also, explain how you would obtain the steam.

99 A gas turbine for an automobile is designed with a regenerator. Air enters the compressor of this engine at 100 kPa and 20°C. The compressor pressure ratio is 8; the maximum cycle temperature is 800°C; and the cold air stream leaves the regenerator 10°C cooler than the hot air stream at the inlet of the regenerator. Assuming both the compressor and the turbine to be isentropic, determine the rates of heat addition and rejection for this cycle when it produces 150 kW. Use constant specific heats at room temperature. *Answers: 303 kW, 153 kW*

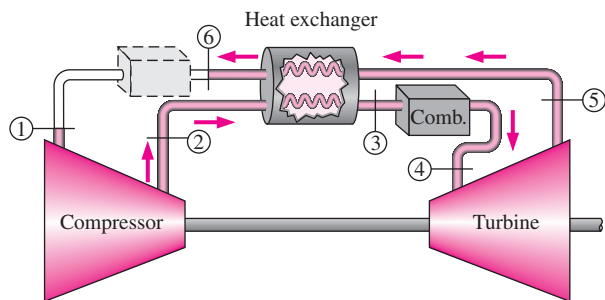

FIGURE P99

100 Rework Prob. 99 when the compressor isentropic efficiency is 87 percent and the turbine isentropic efficiency is 93 percent.

101 A gas turbine engine operates on the ideal Brayton cycle with regeneration, as shown in Fig. P99. Now the regenerator is rearranged so that the air streams of states 2 and 5 enter at one end of the regenerator and streams 3 and 6 exit at the other end (i.e., parallel flow arrangement of a heat exchanger). Consider such a system when air enters the compressor at 100 kPa and 20°C; the compressor pressure ratio is 7; the maximum cycle temperature is 727°C; and the difference between the hot and cold air stream temperatures is 6°C at the end of the regenerator where the cold stream leaves

the regenerator. Is the cycle arrangement shown in the figure more or less efficient than this arrangement? Assume both the compressor and the turbine are isentropic, and use constant specific heats at room temperature.

102E An ideal regenerator ($T_3 = T_2$) is added to a simple ideal Brayton cycle (see Fig. P99). Air enters the compressor of this cycle at 13 psia and 50°F; the pressure ratio is 8; and the maximum cycle temperature is 1500°F. What is the thermal efficiency of this cycle? Use constant specific heats at room temperature. What would the thermal efficiency of the cycle be without the regenerator?

103 Develop an expression for the thermal efficiency of an ideal Brayton cycle with an ideal regenerator of effectiveness 100 percent. Use constant specific heats at room temperature.

104E The idea of using gas turbines to power automobiles was conceived in the 1930s, and considerable research was done in the 1940s and 1950s to develop automotive gas turbines by major automobile manufacturers such as the Chrysler and Ford corporations in the United States and Rover in the United Kingdom. The world's first gas-turbine-powered automobile, the 200-hp Rover Jet 1, was built in 1950 in the United Kingdom. This was followed by the production of the Plymouth Sport Coupe by Chrysler in 1954 under the leadership of G. J. Huebner. Several hundred gas-turbine-powered Plymouth cars were built in the early 1960s for demonstration purposes and were loaned to a select group of people to gather field experience. The users had no complaints other than slow acceleration. But the cars were never mass-produced because of the high production (especially material) costs and the failure to satisfy the provisions of the 1966 Clean Air Act.

A gas-turbine-powered Plymouth car built in 1960 had a turbine inlet temperature of 1700°F, a pressure ratio of 4, and a regenerator effectiveness of 0.9. Using isentropic efficiencies of 80 percent for both the compressor and the turbine, determine the thermal efficiency of this car. Also, determine the mass flow rate of air for a net power output of 95 hp. Assume the ambient air to be at 540 R and 14.5 psia.

105  The 7FA gas turbine manufactured by General Electric is reported to have an efficiency of 35.9 percent in the simple-cycle mode and to produce 159 MW of net power. The pressure ratio is 14.7 and the turbine inlet temperature is 1288°C. The mass flow rate through the turbine is 1,536,000 kg/h. Taking the ambient conditions to be 20°C and 100 kPa, determine the isentropic efficiency of the turbine and the compressor. Also, determine the thermal efficiency of this gas turbine if a regenerator with an effectiveness of 80 percent is added.

106  Reconsider Prob. 105. Using EES (or other) software, develop a solution that allows different isentropic efficiencies for the compressor and turbine and study the effect of the isentropic efficiencies on net work done and the heat supplied to the cycle. Plot the T - s diagram for the cycle.

107 A Brayton cycle with regeneration using air as the working fluid has a pressure ratio of 7. The minimum and maximum temperatures in the cycle are 310 and 1150 K. Assuming an isentropic efficiency of 75 percent for the compressor and 82 percent for the turbine and an effectiveness of 65 percent for the regenerator, determine (a) the air temperature at the turbine exit, (b) the net work output, and (c) the thermal efficiency. *Answers: (a) 783 K, (b) 108.1 kJ/kg, (c) 22.5 percent*

108 A stationary gas-turbine power plant operates on an ideal regenerative Brayton cycle ($\epsilon = 100$ percent) with air as the working fluid. Air enters the compressor at 95 kPa and 290 K and the turbine at 760 kPa and 1100 K. Heat is transferred to air from an external source at a rate of 75,000 kJ/s. Determine the power delivered by this plant (a) assuming constant specific heats for air at room temperature and (b) accounting for the variation of specific heats with temperature.

109 Air enters the compressor of a regenerative gas-turbine engine at 300 K and 100 kPa, where it is compressed to 800 kPa and 580 K. The regenerator has an effectiveness of 72 percent, and the air enters the turbine at 1200 K. For a turbine efficiency of 86 percent, determine (a) the amount of heat transfer in the regenerator and (b) the thermal efficiency. Assume variable specific heats for air. *Answers: (a) 152.5 kJ/kg, (b) 36.0 percent*

110 Repeat Prob. 109 using constant specific heats at room temperature.

111 Repeat Prob. 109 for a regenerator effectiveness of 70 percent.

Carnot Vapor Cycle

112C Why is excessive moisture in steam undesirable in steam turbines? What is the highest moisture content allowed?

113C Why is the Carnot cycle not a realistic model for steam power plants?

114E Water enters the boiler of a steady-flow Carnot engine as a saturated liquid at 180 psia and leaves with a quality of 0.90. Steam leaves the turbine at a pressure of 14.7 psia. Show the cycle on a T - s diagram relative to the saturation lines, and determine (a) the thermal efficiency, (b) the quality at the end of the isothermal heat-rejection process, and (c) the net work output. *Answers: (a) 19.3 percent, (b) 0.153, (c) 148 Btu/lbm*

115 A steady-flow Carnot cycle uses water as the working fluid. Water changes from saturated liquid to saturated vapor as heat is transferred to it from a source at 250°C. Heat rejection takes place at a pressure of 20 kPa. Show the cycle on a T - s diagram relative to the saturation lines, and determine (a) the thermal efficiency, (b) the amount of heat rejected, and (c) the net work output.

116 Repeat Prob. 115 for a heat rejection pressure of 10 kPa.

117 Consider a steady-flow Carnot cycle with water as the working fluid. The maximum and minimum temperatures in the cycle are 350 and 60°C. The quality of water is 0.891 at the beginning of the heat-rejection process and 0.1 at the end. Show the cycle on a T - s diagram relative to the saturation lines, and determine (a) the thermal efficiency, (b) the pressure at the turbine inlet, and (c) the net work output. *Answers: (a) 0.465, (b) 1.40 MPa, (c) 1623 kJ/kg*

The Simple Rankine Cycle

118C What four processes make up the simple ideal Rankine cycle?

119C Consider a simple ideal Rankine cycle with fixed turbine inlet conditions. What is the effect of lowering the condenser pressure on

Pump work input:	(a) increases, (b) decreases, (c) remains the same
Turbine work output:	(a) increases, (b) decreases, (c) remains the same
Heat supplied:	(a) increases, (b) decreases, (c) remains the same
Heat rejected:	(a) increases, (b) decreases, (c) remains the same
Cycle efficiency:	(a) increases, (b) decreases, (c) remains the same
Moisture content at turbine exit:	(a) increases, (b) decreases, (c) remains the same

120C Consider a simple ideal Rankine cycle with fixed turbine inlet temperature and condenser pressure. What is the effect of increasing the boiler pressure on

Pump work input:	(a) increases, (b) decreases, (c) remains the same
Turbine work output:	(a) increases, (b) decreases, (c) remains the same
Heat supplied:	(a) increases, (b) decreases, (c) remains the same
Heat rejected:	(a) increases, (b) decreases, (c) remains the same
Cycle efficiency:	(a) increases, (b) decreases, (c) remains the same
Moisture content at turbine exit:	(a) increases, (b) decreases, (c) remains the same

64 | Fundamentals of Thermal-Fluid Sciences

121C Consider a simple ideal Rankine cycle with fixed boiler and condenser pressures. What is the effect of superheating the steam to a higher temperature on

Pump work input:	(a) increases, (b) decreases, (c) remains the same
Turbine work output:	(a) increases, (b) decreases, (c) remains the same
Heat supplied:	(a) increases, (b) decreases, (c) remains the same
Heat rejected:	(a) increases, (b) decreases, (c) remains the same
Cycle efficiency:	(a) increases, (b) decreases, (c) remains the same
Moisture content at turbine exit:	(a) increases, (b) decreases, (c) remains the same

122C How do actual vapor power cycles differ from idealized ones?

123C Compare the pressures at the inlet and the exit of the boiler for (a) actual and (b) ideal cycles.

124C The entropy of steam increases in actual steam turbines as a result of irreversibilities. In an effort to control entropy increase, it is proposed to cool the steam in the turbine by running cooling water around the turbine casing. It is argued that this will reduce the entropy and the enthalpy of the steam at the turbine exit and thus increase the work output. How would you evaluate this proposal?

125C Is it possible to maintain a pressure of 10 kPa in a condenser that is being cooled by river water entering at 20°C?

The Simple Rankine Cycle

126E The turbine of a steam power plant operating on a simple ideal Rankine cycle produces 500 kW of power when the boiler is operated at 500 psia, the condenser at 6 psia, and the temperature at the turbine entrance is 1200°F. Determine the rate of heat supply in the boiler, the rate of heat rejection in the condenser, and the thermal efficiency of the cycle.

127 A simple ideal Rankine cycle with water as the working fluid operates between the pressure limits of 3 MPa in the boiler and 30 kPa in the condenser. If the quality at the exit of the turbine cannot be less than 85 percent, what is the maximum thermal efficiency this cycle can have? *Answer: 29.7 percent*

128 A simple ideal Rankine cycle with water as the working fluid operates between the pressure limits of 3 MPa in the boiler and 30 kPa in the condenser and a turbine inlet temperature of 700°C. The boiler is sized to provide a steam flow of 50 kg/s. Determine the power produced by the turbine and consumed by the pump.

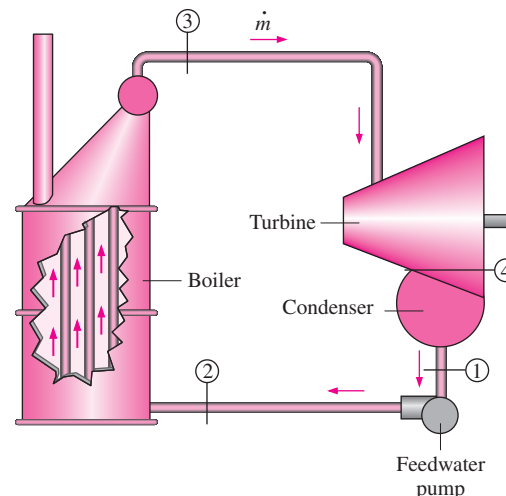

FIGURE P128

129E A simple ideal Rankine cycle with water as the working fluid operates between the pressure limits of 2500 psia in the boiler and 5 psia in the condenser. What is the minimum temperature required at the turbine inlet such that the quality of the steam leaving the turbine is not below 80 percent. When operated at this temperature, what is the thermal efficiency of this cycle?

130 A simple ideal Rankine cycle with water as the working fluid operates between the pressure limits of 15 MPa in the boiler and 100 kPa in the condenser. Saturated steam enters the turbine. Determine the work produced by the turbine, the heat transferred in the boiler, and thermal efficiency of the cycle. *Answer: 699 kJ/kg, 2178 kJ/kg, 31.4 percent*

131 Reconsider Prob. 130. Irreversibilities in the turbine cause the steam quality at the outlet of the turbine to be 70 percent. Determine the isentropic efficiency of the turbine and thermal efficiency of the cycle. *Answers: 87.7 percent, 27.4 percent*

132E A steam Rankine cycle operates between the pressure limits of 2500 psia in the boiler and 1 psia in the condenser. The turbine inlet temperature is 800°F. The turbine isentropic efficiency is 90 percent, the pump losses are negligible, and the cycle is sized to produce 1000 kW of power. Calculate the mass flow rate through the boiler, the power produced by the turbine, the rate of heat supply in the boiler, and the thermal efficiency.

133E Reconsider Prob. 132E. How much error is caused in the thermal efficiency if the power required by the pump were completely neglected?

134 Consider a coal-fired steam power plant that produces 300 MW of electric power. The power plant operates on a simple ideal Rankine cycle with turbine inlet conditions of

5 MPa and 450°C and a condenser pressure of 25 kPa. The coal has a heating value (energy released when the fuel is burned) of 29,300 kJ/kg. Assuming that 75 percent of this energy is transferred to the steam in the boiler and that the electric generator has an efficiency of 96 percent, determine (a) the overall plant efficiency (the ratio of net electric power output to the energy input as fuel) and (b) the required rate of coal supply. *Answers: (a) 24.5 percent, (b) 150 t/h*

135 Consider a solar-pond power plant that operates on a simple ideal Rankine cycle with refrigerant-134a as the working fluid. The refrigerant enters the turbine as a saturated vapor at 1.4 MPa and leaves at 0.7 MPa. The mass flow rate of the refrigerant is 3 kg/s. Show the cycle on a T - s diagram with respect to saturation lines, and determine (a) the thermal efficiency of the cycle and (b) the power output of this plant.

136 Consider a steam power plant that operates on a simple ideal Rankine cycle and has a net power output of 45 MW. Steam enters the turbine at 7 MPa and 500°C and is cooled in the condenser at a pressure of 10 kPa by running cooling water from a lake through the tubes of the condenser at a rate of 2000 kg/s. Show the cycle on a T - s diagram with respect to saturation lines, and determine (a) the thermal efficiency of the cycle, (b) the mass flow rate of the steam, and (c) the temperature rise of the cooling water. *Answers: (a) 38.9 percent, (b) 36 kg/s, (c) 8.4°C*

137 Repeat Prob. 136 assuming an isentropic efficiency of 87 percent for both the turbine and the pump. *Answers: (a) 33.8 percent, (b) 41.4 kg/s , (c) 10.5°C*

138 The net work output and the thermal efficiency for the Carnot and the simple ideal Rankine cycles with steam as the working fluid are to be calculated and compared. Steam enters the turbine in both cases at 10 MPa as a saturated vapor, and the condenser pressure is 20 kPa. In the Rankine cycle, the condenser exit state is saturated liquid and in the Carnot cycle, the boiler inlet state is saturated liquid. Draw the T - s diagrams for both cycles.

139 The schematic of a single-flash geothermal power plant with state numbers is given in Fig. P139. Geothermal resource exists as saturated liquid at 230°C . The geothermal liquid is withdrawn from the production well at a rate of 230 kg/s, and is flashed to a pressure of 500 kPa by an essentially isenthalpic flashing process where the resulting vapor is separated from the liquid in a separator and directed to the turbine. The steam leaves the turbine at 10 kPa with a moisture content of 10 percent and enters the condenser where it is condensed and routed to a reinjection well along with the liquid coming off the separator. Determine (a) the mass flow rate of steam through the turbine, (b) the isentropic efficiency of the turbine, (c) the power output of the turbine, and (d) the thermal efficiency of the plant (the ratio of the turbine work output to the energy of the geothermal fluid relative to

standard ambient conditions). *Answers: (a) 38.2 kg/s, (b) 0.686, (c) 15.4 MW, (d) 7.6 percent*

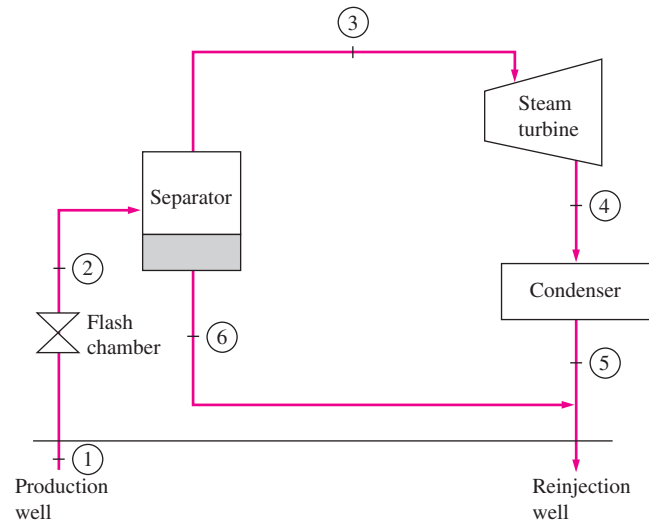

FIGURE P139

140 Reconsider Prob. 139. Now, it is proposed that the liquid water coming out of the separator be routed through another flash chamber maintained at 150 kPa, and the steam produced be directed to a lower stage of the same turbine. Both streams of steam leave the turbine at the same state of 10 kPa and 90 percent quality. Determine (a) the temperature of steam at the outlet of the second flash chamber, (b) the power produced by the lower stage of the turbine, and (c) the thermal efficiency of the plant.

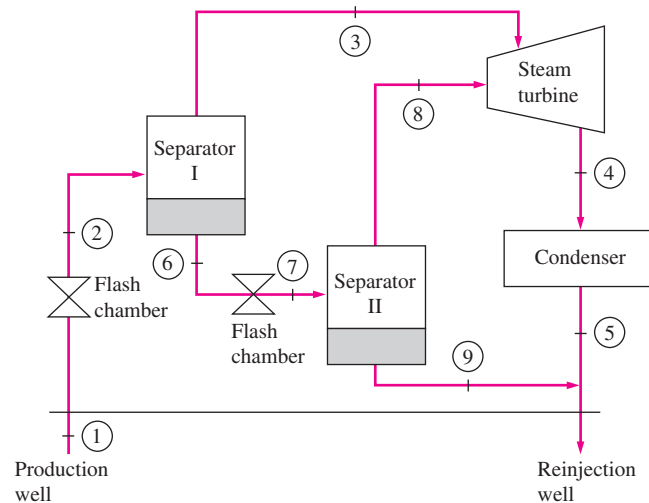

FIGURE P140

66 | Fundamentals of Thermal-Fluid Sciences

141 Reconsider Prob. 139. Now, it is proposed that the liquid water coming out of the separator be used as the heat source in a binary cycle with isobutane as the working fluid. Geothermal liquid water leaves the heat exchanger at 90°C while isobutane enters the turbine at 3.25 MPa and 145°C and leaves at 80°C and 400 kPa. Isobutane is condensed in an air-cooled condenser and then pumped to the heat exchanger pressure. Assuming an isentropic efficiency of 90 percent for the pump, determine (a) the mass flow rate of isobutane in the binary cycle, (b) the net power outputs of both the flashing and the binary sections of the plant, and (c) the thermal efficiencies of the binary cycle and the combined plant. The properties of isobutane may be obtained from EES. *Answers:* (a) 105.5 kg/s, (b) 15.4 MW, 6.14 MW, (c) 12.2 percent, 10.6 percent

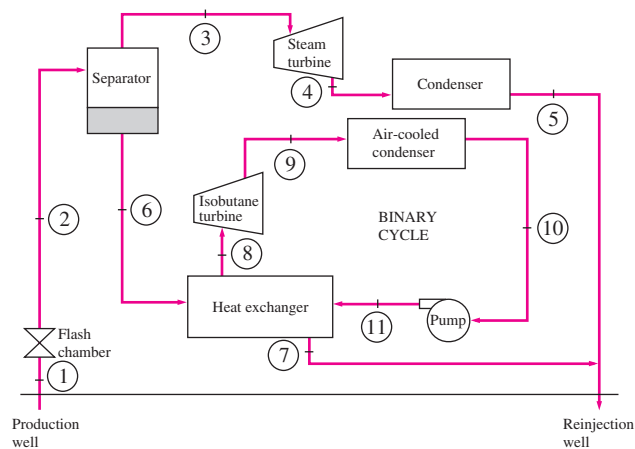

FIGURE P141

The Reheat Rankine Cycle

142C How do the following quantities change when a simple ideal Rankine cycle is modified with reheating? Assume the mass flow rate is maintained the same.

Pump work input:	(a) increases, (b) decreases, (c) remains the same
Turbine work output:	(a) increases, (b) decreases, (c) remains the same
Heat supplied:	(a) increases, (b) decreases, (c) remains the same
Heat rejected:	(a) increases, (b) decreases, (c) remains the same
Moisture content at turbine exit:	(a) increases, (b) decreases, (c) remains the same

143C Is there an optimal pressure for reheating the steam of a Rankine cycle? Explain.

144C Consider a simple ideal Rankine cycle and an ideal Rankine cycle with three reheat stages. Both cycles operate between the same pressure limits. The maximum temperature is 700°C in the simple cycle and 450°C in the reheat cycle. Which cycle do you think will have a higher thermal efficiency?

145  A steam power plant operates on the ideal reheat Rankine cycle. Steam enters the high-pressure turbine at 8 MPa and 500°C and leaves at 3 MPa. Steam is then reheated at constant pressure to 500°C before it expands to 20 kPa in the low-pressure turbine. Determine the turbine work output, in kJ/kg, and the thermal efficiency of the cycle. Also, show the cycle on a T - s diagram with respect to saturation lines.

146  Reconsider Prob. 145. Using EES (or other) software, solve this problem by the diagram window data entry feature of EES. Include the effects of the turbine and pump efficiencies and also show the effects of reheat on the steam quality at the low-pressure turbine exit. Plot the cycle on a T - s diagram with respect to the saturation lines. Discuss the results of your parametric studies.

147E Consider a steam power plant that operates on the ideal reheat Rankine cycle. The plant maintains the inlet of the high-pressure turbine at 600 psia and 600°F , the inlet of the low-pressure turbine at 200 psia and 600°F , and the condenser at 10 psia. The net power produced by this plant is 5000 kW. Determine the rate of heat addition and rejection and the thermal efficiency of the cycle.

148E In Prob. 147E, is there any advantage to operating the reheat section of the boiler at 100 psia rather than 200 psia while maintaining the same low-pressure turbine inlet temperature?

149 Consider a steam power plant that operates on the ideal reheat Rankine cycle. The plant maintains the boiler at 4000 kPa, the reheat section at 500 kPa, and the condenser at 10 kPa. The mixture quality at the exit of both turbines is 90 percent. Determine the temperature at the inlet of each turbine and the cycle's thermal efficiency. *Answer:* 292°C , 283°C , 33.5 percent

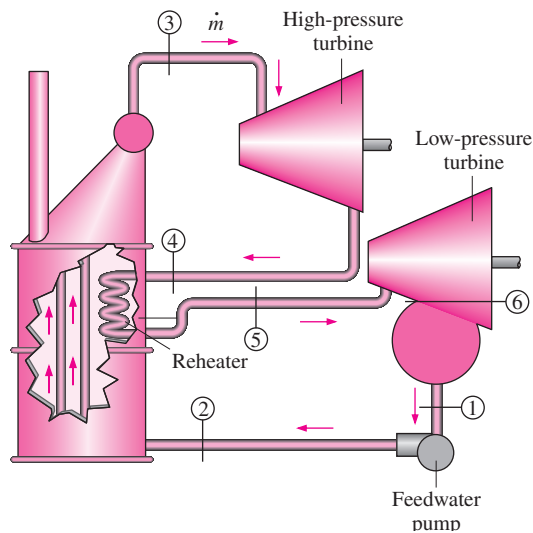

FIGURE P149

150 Consider a steam power plant that operates on the ideal reheat Rankine cycle. The plant maintains the boiler at 17.5 MPa, the reheat at 2 MPa, and the condenser at 50 kPa. The temperature is 550°C at the entrance of the high-pressure turbine, and 300°C at the entrance of the low-pressure turbine. Determine the thermal efficiency of this system.

151 How much does the thermal efficiency of the cycle in Prob. 39 change when the temperature at the entrance to the low-pressure turbine is increased to 550°C?

152 A steam power plant operates on an ideal reheat Rankine cycle between the pressure limits of 15 MPa and 10 kPa. The mass flow rate of steam through the cycle is 12 kg/s. Steam enters both stages of the turbine at 500°C. If the moisture content of the steam at the exit of the low-pressure turbine is not to exceed 10 percent, determine (a) the pressure at which reheating takes place, (b) the total rate of heat input in the boiler, and (c) the thermal efficiency of the cycle. Also, show the cycle on a T - s diagram with respect to saturation lines.

153 A steam power plant operates on the reheat Rankine cycle. Steam enters the high-pressure turbine at 12.5 MPa and 550°C at a rate of 7.7 kg/s and leaves at 2 MPa. Steam is then reheated at constant pressure to 450°C before it expands in the low-pressure turbine. The isentropic efficiencies of the turbine and the pump are 85 percent and 90 percent, respectively. Steam leaves the condenser as a saturated liquid. If the moisture content of the steam at the exit of the turbine is not to exceed 5 percent, determine (a) the condenser pressure, (b) the net power output, and (c) the thermal efficiency.
Answers: (a) 9.73 kPa, (b) 10.2 MW, (c) 36.9 percent

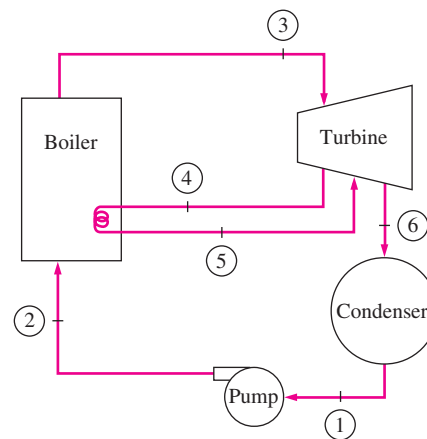

FIGURE P153

The Reversed Carnot Cycle

154C Why is the reversed Carnot cycle executed within the saturation dome not a realistic model for refrigeration cycles?

155 A steady-flow Carnot refrigeration cycle uses refrigerant-134a as the working fluid. The refrigerant changes from saturated vapor to saturated liquid at 30°C in the condenser as it rejects heat. The evaporator pressure is 160 kPa. Show the cycle on a T - s diagram relative to saturation lines, and determine (a) the coefficient of performance, (b) the amount of heat absorbed from the refrigerated space, and (c) the net work input. *Answers: (a) 5.64, (b) 147 kJ/kg, (c) 26.1 kJ/kg*

156E Refrigerant-134a enters the condenser of a steady-flow Carnot refrigerator as a saturated vapor at 90 psia, and it leaves with a quality of 0.05. The heat absorption from the refrigerated space takes place at a pressure of 30 psia. Show the cycle on a T - s diagram relative to saturation lines, and determine (a) the coefficient of performance, (b) the quality at the beginning of the heat-absorption process, and (c) the net work input.

Ideal and Actual Vapor-Compression Refrigeration Cycles

157C Does the ideal vapor-compression refrigeration cycle involve any internal irreversibilities?

158C Why is the throttling valve not replaced by an isentropic turbine in the ideal vapor-compression refrigeration cycle?

159C It is proposed to use water instead of refrigerant-134a as the working fluid in air-conditioning applications where the minimum temperature never falls below the freezing point. Would you support this proposal? Explain.

160C In a refrigeration system, would you recommend condensing the refrigerant-134a at a pressure of 0.7 or 1.0 MPa if heat is to be rejected to a cooling medium at 15°C? Why?

68 | Fundamentals of Thermal-Fluid Sciences

161C Does the area enclosed by the cycle on a T - s diagram represent the net work input for the reversed Carnot cycle? How about for the ideal vapor-compression refrigeration cycle?

162C Consider two vapor-compression refrigeration cycles. The refrigerant enters the throttling valve as a saturated liquid at 30°C in one cycle and as subcooled liquid at 30°C in the other one. The evaporator pressure for both cycles is the same. Which cycle do you think will have a higher COP?

163C The COP of vapor-compression refrigeration cycles improves when the refrigerant is subcooled before it enters the throttling valve. Can the refrigerant be subcooled indefinitely to maximize this effect, or is there a lower limit? Explain.

164 A commercial refrigerator with refrigerant-134a as the working fluid is used to keep the refrigerated space at -30°C by rejecting its waste heat to cooling water that enters the condenser at 18°C at a rate of 0.25 kg/s and leaves at 26°C . The refrigerant enters the condenser at 1.2 MPa and 65°C and leaves at 42°C . The inlet state of the compressor is 60 kPa and -34°C and the compressor is estimated to gain a net heat of 450 W from the surroundings. Determine (a) the quality of the refrigerant at the evaporator inlet, (b) the refrigeration load, (c) the COP of the refrigerator, and (d) the theoretical maximum refrigeration load for the same power input to the compressor.

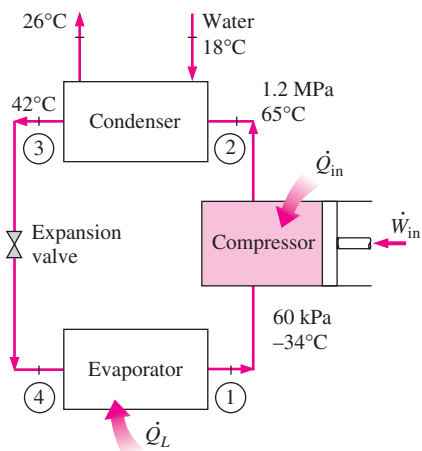

FIGURE P164

165 An ideal vapor-compression refrigeration cycle that uses refrigerant-134a as its working fluid maintains a condenser at 1000 kPa and the evaporator at 4°C . Determine this system's COP and the amount of power required to service a 400 kW cooling load. *Answers: 6.46, 61.9 kW*

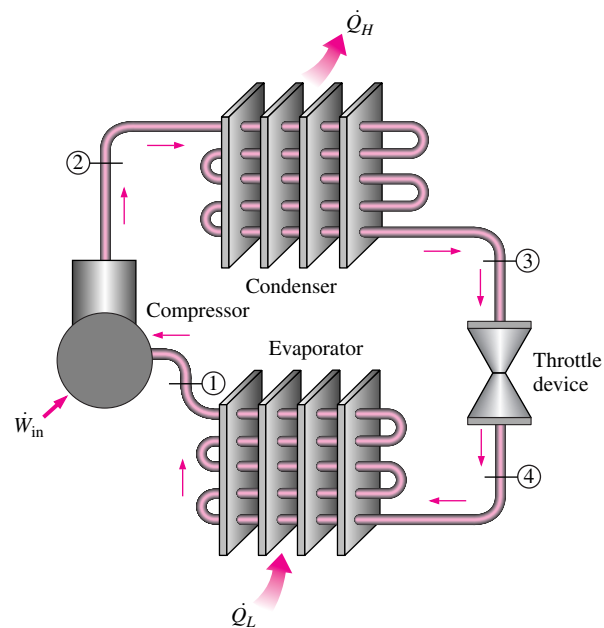



FIGURE P165

166 A 10-kW cooling load is to be served by operating an ideal vapor-compression refrigeration cycle with its evaporator at 400 kPa and its condenser at 800 kPa . Calculate the refrigerant mass flow rate and the compressor power requirement when refrigerant-134a is used.

167E A refrigerator uses refrigerant-134a as its working fluid and operates on the ideal vapor-compression refrigeration cycle. The refrigerant evaporates at -10°F and condenses at 100 psia . This unit serves a $24,000\text{ Btu/h}$ cooling load. Determine the mass flow rate of the refrigerant and the power that this unit will require.

168E  Using EES (or other) software, repeat Prob. 167E if ammonia is used in place of refrigerant-134a.

169 A refrigerator uses refrigerant-134a as the working fluid and operates on an ideal vapor-compression refrigeration cycle between 0.12 and 0.7 MPa . The mass flow rate of the refrigerant is 0.05 kg/s . Show the cycle on a T - s diagram with respect to saturation lines. Determine (a) the rate of heat removal from the refrigerated space and the power input to the compressor, (b) the rate of heat rejection to the environment, and (c) the coefficient of performance. *Answers: (a) 7.41 kW, 1.83 kW, (b) 9.23 kW, (c) 4.06*

170 Repeat Prob. 169 for a condenser pressure of 0.9 MPa .

171 If the throttling valve in Prob. 170 is replaced by an isentropic turbine, determine the percentage increase in the

COP and in the rate of heat removal from the refrigerated space. **Answers:** 4.2 percent, 4.2 percent

172 Refrigerant-134a enters the compressor of a refrigerator as superheated vapor at 0.14 MPa and -10°C at a rate of 0.12 kg/s, and it leaves at 0.7 MPa and 50°C . The refrigerant is cooled in the condenser to 24°C and 0.65 MPa, and it is throttled to 0.15 MPa. Disregarding any heat transfer and pressure drops in the connecting lines between the components, show the cycle on a T - s diagram with respect to saturation lines, and determine (a) the rate of heat removal from the refrigerated space and the power input to the compressor, (b) the isentropic efficiency of the compressor, and (c) the COP of the refrigerator. **Answers:** (a) 19.4 kW, 5.06 kW, (b) 82.5 percent, (c) 3.83

173 An air conditioner using refrigerant-134a as the working fluid and operating on the ideal vapor-compression refrigeration cycle is to maintain a space at 22°C while operating its condenser at 1000 kPa. Determine the COP of the system when a temperature difference of 2°C is allowed for the transfer of heat in the evaporator.

174E A refrigerator operates on the ideal vapor-compression refrigeration cycle and uses refrigerant-134a as the working fluid. The condenser operates at 300 psia and the evaporator at 20°F . If an adiabatic, reversible expansion device were available and used to expand the liquid leaving the condenser, how much would the COP improve by using this device instead of the throttle device? **Answer:** 16.5 percent

175 An ideal vapor-compression refrigeration cycle using refrigerant-134a as the working fluid is used to cool a brine solution to -5°C . This solution is pumped to various buildings for the purpose of air conditioning. The refrigerant evaporates at -10°C with a total mass flow rate of 7 kg/s, and condenses at 600 kPa. Determine the COP of the cycle and the total cooling load.

176 Refrigerant-134a enters the compressor of a refrigerator at 140 kPa and -10°C at a rate of $0.3\text{ m}^3/\text{min}$ and leaves at 1 MPa. The isentropic efficiency of the compressor is 78 percent. The refrigerant enters the throttling valve at 0.95 MPa and 30°C and leaves the evaporator as saturated vapor at -18.5°C . Show the cycle on a T - s diagram with respect to saturation lines, and determine (a) the power input to the compressor, (b) the rate of heat removal from the refrigerated space, and (c) the pressure drop and rate of heat gain in the line between the evaporator and the compressor. **Answers:** (a) 1.88 kW, (b) 4.99 kW, (c) 1.65 kPa, 0.241 kW

177  Reconsider Prob. 176. Using EES (or other) software, investigate the effects of varying the compressor isentropic efficiency over the range 60 to 100 percent and the compressor inlet volume flow rate from 0.1 to $1.0\text{ m}^3/\text{min}$ on the power input and the rate of refrigeration. Plot the rate of refrigeration and the power input to the compressor as functions of compressor efficiency for compressor inlet

volume flow rates of 0.1, 0.5, and $1.0\text{ m}^3/\text{min}$, and discuss the results.

178 A refrigerator uses refrigerant-134a as the working fluid and operates on the ideal vapor-compression refrigeration cycle. The refrigerant enters the evaporator at 120 kPa with a quality of 30 percent and leaves the compressor at 60°C . If the compressor consumes 450 W of power, determine (a) the mass flow rate of the refrigerant, (b) the condenser pressure, and (c) the COP of the refrigerator. **Answers:** (a) 0.00727 kg/s, (b) 672 kPa, (c) 2.43

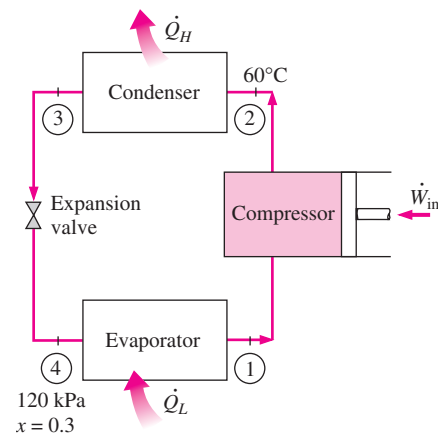

FIGURE P178

Heat Pump Systems

179C Do you think a heat pump system will be more cost-effective in New York or in Miami? Why?

180C What is a water-source heat pump? How does the COP of a water-source heat pump system compare to that of an air-source system?

181 Refrigerant-134a enters the condenser of a residential heat pump at 800 kPa and 55°C at a rate of 0.018 kg/s and leaves at 750 kPa subcooled by 3°C . The refrigerant enters the compressor at 200 kPa superheated by 4°C . Determine (a) the isentropic efficiency of the compressor, (b) the rate of heat supplied to the heated room, and (c) the COP of the heat pump. Also, determine (d) the COP and the rate of heat supplied to the heated room if this heat pump operated on the ideal vapor-compression cycle between the pressure limits of 200 and 800 kPa.

70 | Fundamentals of Thermal-Fluid Sciences

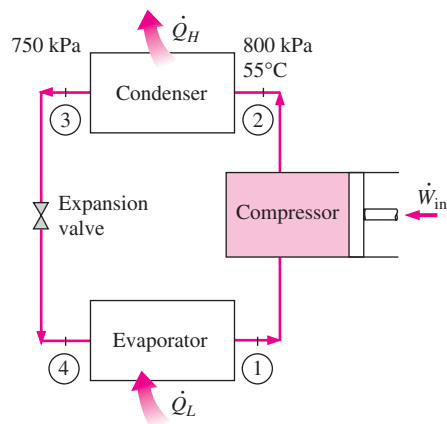

FIGURE P181

182 A heat pump operates on the ideal vapor-compression refrigeration cycle and uses refrigerant-134a as the working fluid. The condenser operates at 1200 kPa and the evaporator at 280 kPa. Determine this system's COP and the rate of heat supplied to the evaporator when the compressor consumes 20 kW.

183 A heat pump using refrigerant-134a as a refrigerant operates its condenser at 800 kPa and its evaporator at -1.25°C . It operates on the ideal vapor-compression refrigeration cycle, except for the compressor, which has an isentropic efficiency of 85 percent. How much do the compressor irreversibilities reduce this heat pump's COP as compared to an ideal vapor-compression refrigeration cycle? *Answer:* 13.1 percent

184 What is the effect on the COP of Prob. 183 when the vapor entering the compressor is superheated by 2°C and the compressor has no irreversibilities?

185E The liquid leaving the condenser of a 100,000 Btu/h heat pump using refrigerant-134a as the working fluid is subcooled by 9.5°F . The condenser operates at 160 psia and the evaporator at 50 psia. How does this subcooling change the power required to drive the compressor as compared to an ideal vapor-compression refrigeration cycle? *Answers:* 4.11 kW, 4.31 kW

186E What is the effect on the compressor power requirement when the vapor entering the compressor of Prob. 185E is superheated by 10°F and the condenser operates ideally?

187 A heat pump with refrigerant-134a as the working fluid is used to keep a space at 25°C by absorbing heat from geothermal water that enters the evaporator at 50°C at a rate of 0.065 kg/s and leaves at 40°C . The refrigerant enters the evaporator at 20°C with a quality of 23 percent and leaves at the inlet pressure as saturated vapor. The refrigerant loses 300 W of heat to the surroundings as it flows through the

compressor and the refrigerant leaves the compressor at 1.4 MPa at the same entropy as the inlet. Determine (a) the degrees of subcooling of the refrigerant in the condenser, (b) the mass flow rate of the refrigerant, (c) the heating load and the COP of the heat pump, and (d) the theoretical minimum power input to the compressor for the same heating load. *Answers:* (a) 3.8°C , (b) 0.0194 kg/s, (c) 3.07 kW, 4.68, (d) 0.238 kW

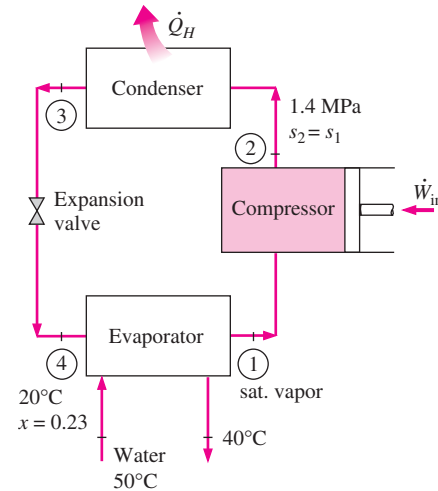

FIGURE P187

Review Problems

188 A four-stroke turbocharged V-16 diesel engine built by GE Transportation Systems to power fast trains produces 3500 hp at 1200 rpm. Determine the amount of power produced per cylinder per (a) mechanical cycle and (b) thermodynamic cycle.

189 Consider a simple ideal Brayton cycle operating between the temperature limits of 300 and 1500 K. Using constant specific heats at room temperature, determine the pressure ratio for which the compressor and the turbine exit temperatures of air are equal.

190 An air-standard cycle with variable specific heats is executed in a closed system with 0.003 kg of air, and it consists of the following three processes:

1-2 Isentropic compression from 100 kPa and 27°C to 700 kPa

2-3 $P = \text{constant}$ heat addition to initial specific volume

3-1 $v = \text{constant}$ heat rejection to initial state

(a) Show the cycle on P - v and T - s diagrams.

(b) Calculate the maximum temperature in the cycle.

(c) Determine the thermal efficiency.

Answers: (b) 2100 K, (c) 15.8 percent

191 Repeat Prob. 190 using constant specific heats at room temperature.

192  A four-cylinder spark-ignition engine has a compression ratio of 8, and each cylinder has a maximum volume of 0.6 L. At the beginning of the compression process, the air is at 98 kPa and 17°C, and the maximum temperature in the cycle is 1800 K. Assuming the engine to operate on the ideal Otto cycle, determine (a) the amount of heat supplied per cylinder, (b) the thermal efficiency, and (c) the number of revolutions per minute required for a net power output of 60 kW. Assume variable specific heats for air.

193  Reconsider Prob. 192. Using EES (or other) software, study the effect of varying the compression ratio from 5 to 11 on the net work done and the efficiency of the cycle. Plot the P - v and T - s diagrams for the cycle, and discuss the results.

194 An ideal gas Carnot cycle uses helium as the working fluid and rejects heat to a lake at 15°C. Determine the pressure ratio, compression ratio, and minimum temperature of the heat source for this cycle to have a thermal efficiency of 50 percent. *Answers: 5.65, 2.83, 576 K*

195E Repeat Prob. 194 when the lake is at 60°F and the Carnot cycle's thermal efficiency is to be 60 percent.

196 A typical hydrocarbon fuel produces 42,000 kJ/kg of heat when used in a spark-ignition engine. Determine the compression ratio required for an ideal Otto cycle to use 0.043 grams of fuel to produce 1 kJ of work. Use constant specific heats at room temperature. *Answer: 7.52*

197 The cutoff ratio, r_c and the pressure ratio during constant-volume heat addition process, r_p , determine the amount of heat added to the dual cycle. Develop an equation for $q_{in}/(c_v T_1 r^{k-1})$ in terms of k , r_c and r_p . Use constant specific heats at room temperature.

198 An ideal Otto cycle has a compression ratio of 9.2 and uses air as the working fluid. At the beginning of the compression process, air is at 98 kPa and 27°C. The pressure is doubled during the constant-volume heat-addition process. Accounting for the variation of specific heats with temperature, determine (a) the amount of heat transferred to the air, (b) the net work output, (c) the thermal efficiency, and (d) the mean effective pressure for the cycle.

199 Repeat Prob. 198 using constant specific heats at room temperature.

200 Consider an engine operating on the ideal Diesel cycle with air as the working fluid. The volume of the cylinder is 1200 cm³ at the beginning of the compression process, 75 cm³ at the end, and 150 cm³ after the heat-addition process. Air is at 17°C and 100 kPa at the beginning of the compression process. Determine (a) the pressure at the beginning of the heat-rejection process, (b) the net work per cycle, in kJ, and (c) the mean effective pressure.

201 Repeat Prob. 200 using argon as the working fluid.

202E An ideal dual cycle has a compression ratio of 12 and uses air as the working fluid. At the beginning of the compression process, air is at 14.7 psia and 90°F, and occupies a volume of 75 in³. During the heat-addition process, 0.3 Btu of heat is transferred to air at constant volume and 1.1 Btu at constant pressure. Using constant specific heats evaluated at room temperature, determine the thermal efficiency of the cycle.

203 Consider a simple ideal Brayton cycle with air as the working fluid. The pressure ratio of the cycle is 6, and the minimum and maximum temperatures are 300 and 1300 K, respectively. Now the pressure ratio is doubled without changing the minimum and maximum temperatures in the cycle. Determine the change in (a) the net work output per unit mass and (b) the thermal efficiency of the cycle as a result of this modification. Assume variable specific heats for air. *Answers: (a) 41.5 kJ/kg, (b) 10.6 percent*

204 Repeat Prob. 203 using constant specific heats at room temperature.

205 A gas-turbine engine with regeneration operates with two stages of compression and two stages of expansion. The pressure ratio across each stage of the compressor and turbine is 3.5. The air enters each stage of the compressor at 300 K and each stage of the turbine at 1200 K. The compressor and turbine efficiencies are 78 and 86 percent, respectively, and the effectiveness of the regenerator is 72 percent. Determine the back work ratio and the thermal efficiency of the cycle, assuming constant specific heats for air at room temperature. *Answers: 53.2 percent, 39.2 percent*

206  Reconsider Prob. 205. Using EES (or other) software, study the effects of varying the isentropic efficiencies for the compressor and turbine and regenerator effectiveness on net work done and the heat supplied to the cycle for the variable specific heat case. Let the isentropic efficiencies and the effectiveness vary from 70 percent to 90 percent. Plot the T - s diagram for the cycle.

207 Repeat Prob. 205 using helium as the working fluid.

208 A Brayton cycle with a pressure ratio of 15 operates with air entering the compressor at 70 kPa and 0°C, and the turbine at 600°C. Calculate the net specific work produced by this cycle treating the air as an ideal gas with (a) constant specific heats, and (b) variable specific heats.

72 | Fundamentals of Thermal-Fluid Sciences

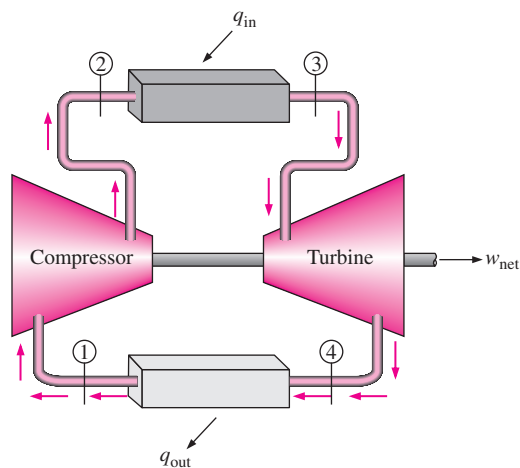





FIGURE P208

209 An Otto cycle with a compression ratio of 8 begins its compression at 94 kPa and 10°C. The maximum cycle temperature is 900°C. Utilizing air-standard assumptions, determine the thermal efficiency of this cycle using (a) constant specific heats at room temperature and (b) variable specific heats. *Answers: (a) 56.5 percent, (b) 53.7 percent*

210 A Diesel cycle has a compression ratio of 22 and begins its compression at 85 kPa and 15°C. The maximum cycle temperature is 1200°C. Utilizing air-standard assumptions, determine the thermal efficiency of this cycle using (a) constant specific heats at room temperature and (b) variable specific heats.

211  Using EES (or other) software, determine the effects of compression ratio on the net work output and the thermal efficiency of the Otto cycle for a maximum cycle temperature of 2000 K. Take the working fluid to be air that is at 100 kPa and 300 K at the beginning of the compression process, and assume variable specific heats. Vary the compression ratio from 6 to 15 with an increment of 1. Tabulate and plot your results against the compression ratio.

212  Using EES (or other) software, determine the effects of pressure ratio on the net work output and the thermal efficiency of a simple Brayton cycle for a maximum cycle temperature of 1800 K. Take the working fluid to be air that is at 100 kPa and 300 K at the beginning of the compression process, and assume variable specific heats. Vary the pressure ratio from 5 to 24 with an increment of 1. Tabulate and plot your results against the pressure ratio. At what pressure ratio does the net work output become a maximum? At what pressure ratio does the thermal efficiency become a maximum?

213  Repeat Problem 212 assuming isentropic efficiencies of 85 percent for both the turbine and the compressor.

214  Using EES (or other) software, determine the effects of pressure ratio, maximum cycle temperature, and compressor and turbine efficiencies on the net work output per unit mass and the thermal efficiency of a simple Brayton cycle with air as the working fluid. Air is at 100 kPa and 300 K at the compressor inlet. Also, assume constant specific heats for air at room temperature. Determine the net work output and the thermal efficiency for all combinations of the following parameters, and draw conclusions from the results.

Pressure ratio:	5, 8, 14
Maximum cycle temperature:	800, 1200, 1600 K
Compressor isentropic efficiency:	80, 100 percent
Turbine isentropic efficiency:	80, 100 percent

215  Repeat Problem 214 by considering the variation of specific heats of air with temperature.

216  Repeat Problem 214 using helium as the working fluid.

217  Using EES (or other) software, determine the effect of the number of compression and expansion stages on the thermal efficiency of an ideal regenerative Brayton cycle with multistage compression and expansion. Assume that the overall pressure ratio of the cycle is 12, and the air enters each stage of the compressor at 300 K and each stage of the turbine at 1200 K. Using constant specific heats for air at room temperature, determine the thermal efficiency of the cycle by varying the number of stages from 1 to 22 in increments of 3. Plot the thermal efficiency versus the number of stages. Compare your results to the efficiency of an Ericsson cycle operating between the same temperature limits.

218  Repeat Problem 217 using helium as the working fluid.

219 Show that the thermal efficiency of a combined gas–steam power plant η_{cc} can be expressed as

$$\eta_{cc} = \eta_g + \eta_s - \eta_g \eta_s$$

where $\eta_g = W_g/Q_{in}$ and $\eta_s = W_s/Q_{g,out}$ are the thermal efficiencies of the gas and steam cycles, respectively. Using this relation, determine the thermal efficiency of a combined power cycle that consists of a topping gas-turbine cycle with an efficiency of 40 percent and a bottoming steam-turbine cycle with an efficiency of 30 percent.

220 It can be shown that the thermal efficiency of a combined gas–steam power plant η_{cc} can be expressed in terms of the thermal efficiencies of the gas- and the steam-turbine cycles as

$$\eta_{cc} = \eta_g + \eta_s - \eta_g \eta_s$$

Prove that the value of η_{cc} is greater than either of η_g or η_s . That is, the combined cycle is more efficient than either of the gas-turbine or steam-turbine cycles alone.

221 Consider a steam power plant operating on the ideal Rankine cycle with reheat between the pressure limits of 25 MPa and 10 kPa with a maximum cycle temperature of 600°C and a moisture content of 8 percent at the turbine exit. For a reheat temperature of 600°C, determine the reheat pressures of the cycle for the cases of (a) single and (b) double reheat.

222E The Stillwater geothermal power plant in Nevada, which started full commercial operation in 1986, is designed to operate with seven identical units. Each of these seven units consists of a pair of power cycles, labeled Level I and Level II, operating on the simple Rankine cycle using an organic fluid as the working fluid.

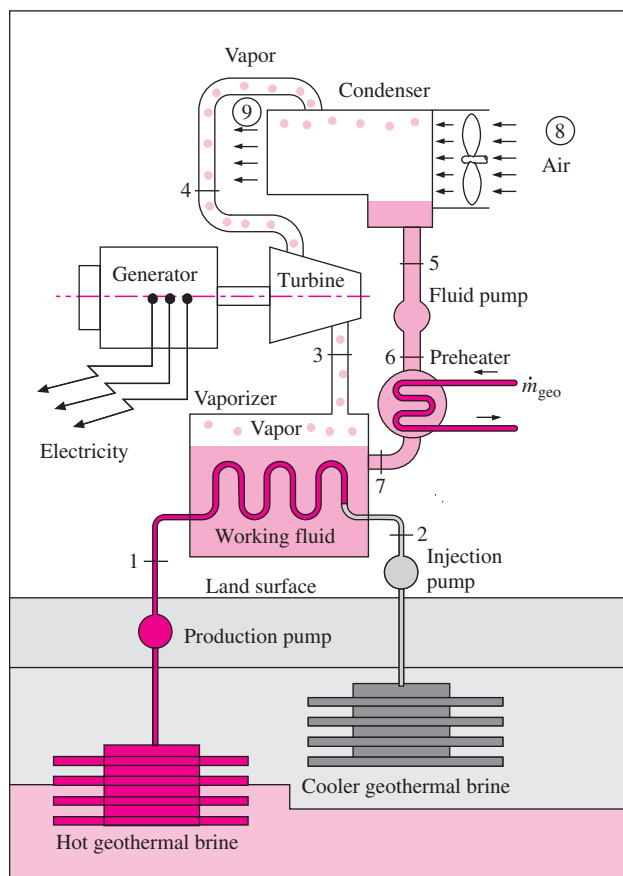

FIGURE P222E

Schematic of a binary geothermal power plant.

Courtesy of ORMAT Energy Systems, Inc.

The heat source for the plant is geothermal water (brine) entering the vaporizer (boiler) of Level I of each unit at 325°F at a rate of 384,286 lbm/h and delivering 22.79 MBtu/h (“M” stands for “million”). The organic fluid that enters the vaporizer at 202.2°F at a rate of 157,895 lbm/h leaves it at 282.4°F and 225.8 psia as saturated vapor. This saturated vapor expands in the turbine to 95.8°F and 19.0 psia and produces 1271 kW of electric power. About 200 kW of this power is used by the pumps, the auxiliaries, and the six fans of the condenser. Subsequently, the organic working fluid is condensed in an air-cooled condenser by air that enters the condenser at 55°F at a rate of 4,195,100 lbm/h and leaves at 84.5°F. The working fluid is pumped and then preheated in a preheater to 202.2°F by absorbing 11.14 MBtu/h of heat from the geothermal water (coming from the vaporizer of Level II) entering the preheater at 211.8°F and leaving at 154.0°F.

Taking the average specific heat of the geothermal water to be 1.03 Btu/lbm · °F, determine (a) the exit temperature of the geothermal water from the vaporizer, (b) the rate of heat rejection from the working fluid to the air in the condenser, (c) the mass flow rate of the geothermal water at the preheater, and (d) the thermal efficiency of the Level I cycle of this geothermal power plant. *Answers: (a) 267.4°F, (b) 29.7 MBtu/h, (c) 187,120 lbm/h, (d) 10.8 percent*

223 A steam power plant operates on an ideal Rankine cycle with two stages of reheat and has a net power output of 120 MW. Steam enters all three stages of the turbine at 500°C. The maximum pressure in the cycle is 15 MPa, and the minimum pressure is 5 kPa. Steam is reheated at 5 MPa the first time and at 1 MPa the second time. Show the cycle on a T - s diagram with respect to saturation lines, and determine (a) the thermal efficiency of the cycle and (b) the mass flow rate of the steam. *Answers: (a) 45.5 percent, (b) 64.4 kg/s*

224 A steam power plant operating on a simple ideal Rankine cycle maintains the boiler at 6000 kPa, the turbine inlet at 600°C, and the condenser at 50 kPa. Compare the thermal efficiency of this cycle when it is operated so that the liquid enters the pump as a saturated liquid against that when the liquid enters the pump 11.3°C cooler than a saturated liquid at the condenser pressure.

225  Using EES (or other) software, investigate the effect of the condenser pressure on the performance of a simple ideal Rankine cycle. Turbine inlet conditions of steam are maintained constant at 5 MPa and 500°C while the condenser pressure is varied from 5 to 100 kPa. Determine the thermal efficiency of the cycle and plot it against the condenser pressure, and discuss the results.

226  Using EES (or other) software, investigate the effect of superheating the steam on the performance of a simple ideal Rankine cycle. Steam enters the turbine at 3 MPa and exits at 10 kPa. The turbine inlet temperature is varied from 250 to 1100°C. Determine the thermal efficiency

74 | Fundamentals of Thermal-Fluid Sciences

of the cycle and plot it against the turbine inlet temperature, and discuss the results.

227  Using EES (or other) software, investigate the effect of number of reheat stages on the performance of an ideal Rankine cycle. The maximum and minimum pressures in the cycle are 15 MPa and 10 kPa, respectively, and steam enters all stages of the turbine at 500°C. For each case, maintain roughly the same pressure ratio across each turbine stage. Determine the thermal efficiency of the cycle and plot it against the number of reheat stages 1, 2, 4, and 8, and discuss the results.

228 Consider a steady-flow Carnot refrigeration cycle that uses refrigerant-134a as the working fluid. The maximum and minimum temperatures in the cycle are 30 and -20°C , respectively. The quality of the refrigerant is 0.15 at the beginning of the heat absorption process and 0.80 at the end. Show the cycle on a T - s diagram relative to saturation lines, and determine (a) the coefficient of performance, (b) the condenser and evaporator pressures, and (c) the net work input.

229 A heat pump that operates on the ideal vapor-compression cycle with refrigerant-134a is used to heat a house. The mass flow rate of the refrigerant is 0.32 kg/s. The condenser and evaporator pressures are 900 and 200 kPa, respectively. Show the cycle on a T - s diagram with respect to saturation lines, and determine (a) the rate of heat supply to the house, (b) the volume flow rate of the refrigerant at the compressor inlet, and (c) the COP of this heat pump.

230 Rooms with floor areas of up to 15-m^2 are cooled adequately by window air conditioners whose cooling capacity is 5000 Btu/h. Assuming the COP of the air conditioner to be 3.5, determine the rate of heat gain of the room, in Btu/h, when the air conditioner is running continuously to maintain a constant room temperature.

231 A heat pump water heater (HPWH) heats water by absorbing heat from the ambient air and transferring it to water. The heat pump has a COP of 2.2 and consumes 2 kW of electricity when running. Determine if this heat pump can be used to meet the cooling needs of a room most of the time for “free” by absorbing heat from the air in the room. The rate of heat gain of a room is usually less than 5000 kJ/h.

232 A heat pump operates on the ideal vapor-compression refrigeration cycle and uses refrigerant-22 as the working fluid. The operating conditions for this heat pump are evaporator saturation temperature of -5°C and the condenser saturation temperature of 45°C . Selected data for refrigerant-22 are provided in the table below.

T , $^{\circ}\text{C}$	P_{sat} , kPa	h_f , kJ/kg	h_g , kJ/kg	s_g , kJ/kg \cdot K
-5	421.2	38.76	248.1	0.9344
45	1728	101	261.9	0.8682

For R-22 at $P = 1728$ kPa and $s = 0.9344$ kJ/kg \cdot K, $T = 68.15^{\circ}\text{C}$ and $h = 283.7$ kJ/kg. Also, take $c_{p, \text{air}} = 1.005$ kJ/kg \cdot K.

(a) Sketch the hardware and the T - s diagram for this heat pump application. (b) Determine the COP for this unit. (c) The condenser of this unit is located inside the air handler of an office. If the air flowing through the air handler is limited to a 20°C temperature rise, determine the ratio of volume flow rate of air to mass flow rate of R-22 through the air handler, in $(\text{m}_{\text{air}}^3/\text{min})/(\text{kg}_{\text{R-22}}/\text{s})$.

233 Consider an ice producing plant that operates on the ideal vapor-compression refrigeration cycle and uses refrigerant-134a as the working fluid. The refrigeration cycle operating conditions require an evaporator pressure of 140 kPa and the condenser pressure of 1200 kPa. Cooling water flows through the water jacket surrounding the condenser and is supplied at the rate of 200 kg/s. The cooling water has a 10°C temperature rise as it flows through the water jacket. To produce ice, potable water is supplied to the chiller section of the refrigeration cycle. For each kg of ice produced 333 kJ of energy must be removed from the potable water supply.

(a) Sketch the hardware for all three working fluids of this refrigerant-ice making system and the T - s diagram for refrigeration cycle. (b) Determine the mass flow rate of the refrigerant, in kg/s. (c) Determine the mass flow rate of the potable water supply, in kg/s.

234  Using EES (or other) software, investigate the effect of the evaporator pressure on the COP of an ideal vapor-compression refrigeration cycle with R-134a as the working fluid. Assume the condenser pressure is kept constant at 1 MPa while the evaporator pressure is varied from 100 kPa to 500 kPa. Plot the COP of the refrigeration cycle against the evaporator pressure, and discuss the results.

235  Using EES (or other) software, investigate the effect of the condenser pressure on the COP of an ideal vapor-compression refrigeration cycle with R-134a as the working fluid. Assume the evaporator pressure is kept constant at 120 kPa while the condenser pressure is varied from 400 to 1400 kPa. Plot the COP of the refrigeration cycle against the condenser pressure, and discuss the results.

Design and Essay Problems

236 Design a closed-system air-standard gas power cycle composed of three processes and having a minimum thermal efficiency of 20 percent. The processes may be isothermal, isobaric, isochoric, isentropic, polytropic, or pressure as a linear function of volume; however, the Otto, Diesel, Ericsson, and Stirling cycles may not be used. Prepare an engineering report describing your design, showing the system, P - v and T - s diagrams, and sample calculations.

237 Write an essay on the most recent developments on the two-stroke engines, and find out when we might be seeing cars powered by two-stroke engines in the market. Why do the major car manufacturers have a renewed interest in two-stroke engines?

238 Exhaust gases from the turbine of a simple Brayton cycle are quite hot and may be used for other thermal purposes. One proposed use is generating saturated steam at 110°C from water at 30°C in a boiler. This steam will be distributed to several buildings on a college campus for space heating. A Brayton cycle with a pressure ratio of 6 is to be used for this purpose. Plot the power produced, the flow rate of produced steam, and the maximum cycle temperature as functions of the rate at which heat is added to the cycle. The temperature at the turbine inlet is not to exceed 2000°C .

239 A gas turbine operates with a regenerator and two stages of reheating and intercooling. This system is designed so that when air enters the compressor at 100 kPa and 15°C , the pressure ratio for each stage of compression is 3; the air temperature when entering a turbine is 500°C ; and the regenerator operates perfectly. At full load, this engine produces 800 kW . For this engine to service a partial load, the heat addition in both combustion chambers is reduced. Develop an optimal schedule of heat addition to the combustion chambers for partial loads ranging from 400 kW to 800 kW .

240 You have been asked to design a power facility for lunar-based laboratory. You have selected a simple Brayton cycle that uses argon as the working fluid and has a pressure ratio of 6. The heat-rejecting heat exchanger maintains the state at the entrance to the compressor at 50 kPa and -20°C . You have elected to use solar collectors to serve as the heat supply. Tests of these collectors give the temperature increase results shown in the figure. Develop a plot of the power that will be produced by this system and its thermal efficiency as a function of the argon mass flow rate. Is there a “best” flow rate at which to operate this power plant?

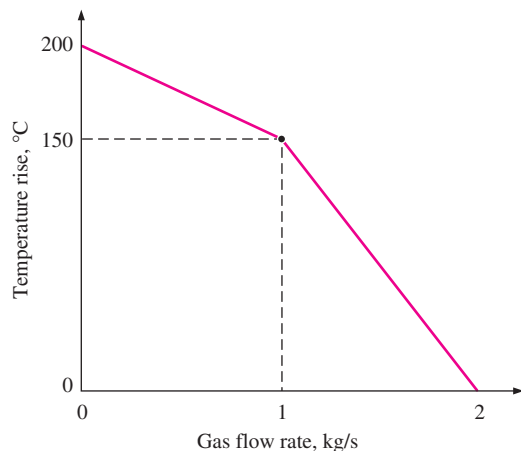

FIGURE P240

241 Design a steam power cycle that can achieve a cycle thermal efficiency of at least 40 percent under the conditions that all turbines have isentropic efficiencies of 85 percent and all pumps have isentropic efficiencies of 60 percent. Prepare an engineering report describing your design. Your design report must include, but is not limited to, the following:

- Discussion of various cycles attempted to meet the goal as well as the positive and negative aspects of your design.
- System figures and T - s diagrams with labeled states and temperature, pressure, enthalpy, and entropy information for your design.
- Sample calculations.

242 Contact your power company and obtain information on the thermodynamic aspects of their most recently built power plant. If it is a conventional power plant, find out why it is preferred over a highly efficient combined power plant.

243 A 10-MW geothermal power plant is being considered at a site where geothermal water at 230°C is available. Geothermal water is to be flashed into a chamber to a lower pressure where part of the water evaporates. The liquid is returned to the ground while the vapor is used to drive the steam turbine. The pressures at the turbine inlet and the turbine exit are to remain above 200 kPa and 8 kPa , respectively. High-pressure flash chambers yield a small amount of steam with high exergy whereas lower-pressure flash chambers yield considerably more steam but at a lower exergy. By trying several pressures, determine the optimum pressure of the flash chamber to maximize the power production per unit mass of geothermal water withdrawn. Also, determine the thermal efficiency for each case assuming 10 percent of the power produced is used to drive the pumps and other auxiliary equipment.

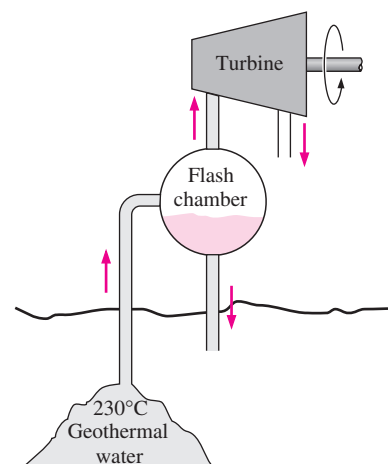

FIGURE P243

76 | Fundamentals of Thermal-Fluid Sciences

244 A natural gas-fired furnace in a textile plant is used to provide steam at 130°C . At times of high demand, the furnace supplies heat to the steam at a rate of 30 MJ/s . The plant also uses up to 6 MW of electrical power purchased from the local power company. The plant management is considering converting the existing process plant into a cogeneration plant to meet both their process-heat and power requirements. Your job is to come up with some designs. Designs based on a gas turbine or a steam turbine are to be considered. First decide whether a system based on a gas turbine or a steam turbine will best serve the purpose, considering the cost and the complexity. Then propose your design for the cogeneration plant complete with pressures and temperatures and the mass flow rates. Show that the proposed design meets the power and process-heat requirements of the plant.

245 Design the condenser of a steam power plant that has a thermal efficiency of 40 percent and generates 10 MW of net electric power. Steam enters the condenser as saturated vapor at 10 kPa , and it is to be condensed outside horizontal tubes through which cooling water from a nearby river flows. The temperature rise of the cooling water is limited to 8°C , and the velocity of the cooling water in the pipes is limited to 6 m/s to keep the pressure drop at an acceptable level. From prior experience, the average heat flux based on the outer surface of the tubes can be taken to be $12,000\text{ W/m}^2$. Specify the pipe diameter, total pipe length, and the arrangement of the pipes to minimize the condenser volume.

246 The heat supplied by a heat pump used to maintain a building's temperature is often supplemented by another source of direct heat. The fraction of the total heat required that is supplied by supplemental heat increases as the temperature of the environmental air (which serves as the low-temperature sink) decreases. Develop a supplemental heat schedule as a function of the environmental air temperature that minimizes the total supplemental and heat-pump energy required to service the building.

247 Consider a cascaded vapor compression refrigeration system that uses the same working fluid in both systems. Is there a pressure at which to operate the heat exchanger that will optimize the overall COP?

248 Consider a solar pond power plant operating on a closed Rankine cycle. Using refrigerant-134a as the working

fluid, specify the operating temperatures and pressures in the cycle, and estimate the required mass flow rate of refrigerant-134a for a net power output of 50 kW . Also, estimate the surface area of the pond for this level of continuous power production. Assume that the solar energy is incident on the pond at a rate of 500 W per m^2 of pond area at noontime, and that the pond is capable of storing 15 percent of the incident solar energy in the storage zone.

249 It is proposed to use a solar-powered thermoelectric system installed on the roof to cool residential buildings. The system consists of a thermoelectric refrigerator that is powered by a thermoelectric power generator whose top surface is a solar collector. Discuss the feasibility and the cost of such a system, and determine if the proposed system installed on one side of the roof can meet a significant portion of the cooling requirements of a typical house in your area.

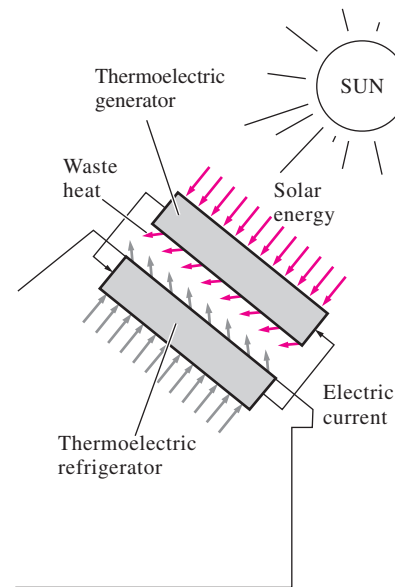

FIGURE P249